

## OPTIDRIVE™

# STOCK DRIVES CATALOGUE

*Variable speed drives  
& accessories*



Applications solved...



# Global Solutions...

wireless control for  
hundreds of applications

Invertek Drives Ltd are dedicated to the design, manufacture and marketing of electronic variable speed drives for controlling electric motors.

The state of the art UK headquarters houses specialist facilities for research & development, manufacturing and global marketing. All operations, including research and development, are accredited to the exacting customer focused ISO 9001:2000 quality standard.

The Company's products are sold globally by a network of specialist distributors in over 60 different countries. Invertek Drives' unique and innovative Optidrive range is designed for ease of use and installation and meets recognised international design standards for CE (Europe), cUL (North America) and CTick (Australia).

with Invertek Drives  
the solutions start here!

- easy to use and incredible performance
- leading edge design and technology
- highly committed to innovation
- wireless control for hundreds of applications
- products you can rely on
- global support and suppliers



**INVERTEK  
DRIVES**  
www.invertek.co.uk

**VARIABLE SPEED DRIVES**

<b>OPTIDRIVE PLUS 3<sup>GV</sup></b>	Pages 2—5
<b>OPTIDRIVE VTC</b>	6—7
<b>OPTIDRIVE E2</b>	10—13
<b>OPTIDRIVE E2 SINGLE PHASE</b>	14—15
<b>OPTIDRIVE IP55 / NEMA 12</b>	16—17
<b>OPTIDRIVE IP66 / NEMA 4X</b>	18—19

**OPTIONS**

**INSTALLATION**

Optifilter	20
Optibrake	21
Input Chokes	22
Outut Filters	23

**I/O OPTIONS**

<b>3ROUT, 2ROUT, HVACO, LOGIP</b>	24
<b>External Encoder Module</b>	25

**CONFIGURATION / MONITORING**

Optiport Plus / E2	26
--------------------	----

**DATA CABLES & ACCESSORIES**

Splitters, Cables & Adaptors	27
------------------------------	----

**SOFTWARE**

Optiwand PDA / SP	28
Optistore V3	29

**COMMUNICATION**

**FIELDBUS COMMUNICATION**

Ethernet, Profibus & DeviceNet	30
--------------------------------	----

**COMPATIBLTY REFERENCE**

Options Compatibility	31
-----------------------	----

**TRAINING**

Training Courses	32
------------------	----



# OPTIDRIVE PLUS 3<sup>GV</sup>

## 3<sup>rd</sup> Generation Vector Control

AC Variable Speed Drive  
0.37kW – 160kW (0.5 – 250HP)  
200 – 600V

200% torque down to 0.0Hz, reliable high speed operation and infra red communication

Optidrive Plus 3<sup>GV</sup> is the natural evolution of the Optidrive family adding ultimate motor control to established Optidrive benchmarks of control and ease of use.

Optidrive Plus 3<sup>GV</sup> uses 3<sup>GV</sup> technology, a revolutionary and patented motor control strategy. 3<sup>GV</sup> technology delivers 200% torque down to 0.0Hz allowing this unique open loop product to be used without any feedback device in many traditional closed loop applications.

Only the motor name plate data is required to achieve optimum performance, the drive continuously and automatically determines and tracks the key motor characteristics required for vector control.

Optidrive Plus 3<sup>GV</sup> can be commissioned using the unique Optiwand PDA software designed for use on pocket pc's. Communication takes place without wires using infrared light to quickly and accurately transfer data.

### Key Benefits

- Compact Design for reduced panel space requirements
- Easy Key Mounting Slots giving fast and easy installation
- Pluggable Control Terminals enable simple, easy access control wiring
- Up to 50°C Ambient Temperature, rugged design for harsh environments
- Internal RFI Filter for compliance with the latest EMC standards
- 14 Basic Parameters allow fast commission with powerful yet simple features
- High Visibility LED Display with user scaling, easy to read
- 32kHz Output Switching Frequency for ultra quiet motor operation
- 150% Overload for 60 Seconds (175% for 2 seconds), high starting capacity for demanding applications
- Mains dip ride through allows continuous operation through short periods of supply loss
- Built in Master—Slave control function with fast set up and selectable scaling
- Built in Infra Red programming port requires no cables



### Industry Sectors

- Plastics
- Machine Tools
- Rubber
- Cranes
- Pumping
- Elevators
- Chemical



Specification		OPTIDRIVE PLUS 3 <sup>GV</sup>	
Output Ratings	Overload capacity	150% for 60 secs; 175% for 2 secs	
	Frequency	0...500Hz	
Input Ratings	Frequency	48–62Hz	
	Voltage	200–240V ± 10% 1 Phase (0.37–22kW / 0.5–30HP) 200–240V ± 10% 3 Phase (1.5–90kW / 2–120HP) 380–480V ± 10% 1 Phase (0.75–90kW / 1–105HP) 380–480V ± 10% 3 Phase (1.5–160kW / 2–250HP) 480–525V ± 10% 3 Phase (55–200kW) 500–600V ± 10% 3 Phase (1.5–45kW / 2–60HP)	
Ambient Conditions	Temperature	Operating: -10 to 50°C max; Storage: -40 to 60°C	
	Altitude	0–2000m (derate 5% per 100m above 1000m)	
	Ingress protection	IP20; Optional IP55	
Programming	Keypad	Yes	
	PC	Yes	
	PDA	Yes	
Control Specification	Control method	V / F 3 <sup>GV</sup> Sensorless Vector Closed Loop Vector (with optional encoder feedback interface)	
	PWM Frequency	4...32kHz (effective)	
	V/Hz ratio	Linear (1 adjustment point)	
	Boost	Automatic after autotune	
	Stop mode	Coast/Ramp/DC Brake	
	Internal brake transistor	Yes (sizes 2–6); External resistor required	
	Capacity	100% Drive Rated Power continuously	
	Skip frequency	One point, adjustable frequency band	
	Frequency setpoint control		0...10V DC ± 10V DC 0...24V DC 4...20mA 0...20mA Digital—Keypad RS485 (Master Slave) Modbus RTU
		Preset speeds	8
		PI control	Yes
		Spin start	Yes
		Acceleration	0...3000 secs
	Deceleration	(2 ramps) 0...3000 secs	
	S Curve accel/decel	Firmware Download Available	
	PC setup software	Optistore V3	
	Programmable I/O	Input 1	Programmable Digital Input
Input 2 / Output 2		User-selectable Digital Input / Output	
Input 3		User-selectable Unipolar Analogue / Digital Input	
Input 4		User-selectable Bipolar Analogue / Digital Input	
Output 1		Programmable Analogue / Digital Output	
Relay 1		Relay Output (30V DC 5A, 250V AC 6A)	
Keypad Display	Operating display	Output Frequency, Current, RPM, Power and User Scalable values	
	Remote mount	Optional Optiport Plus remote mounting keypad	
Motor Feedback	Feedback type	With Encoder Module — HTL or TTL	
	Pulses / Rev	Adjustable	
	Max. Frequency	500kHz	
Protective Functions	Inverter trip	Over voltage, over current, under voltage, external trip, motor overload, over temperature, short circuited, earth fault	
	Memory	Last 4 trips stored	
Bus Communication	Modbus RTU	Standard	
	Profibus DP	via Gateway	
	DeviceNet	via Gateway	
	RS485 (Optibus)	Standard	
Standards Compliance	EN 61800-3:2004	Adjustable speed electrical power drive systems. EMC requirements.	
Additional Features		Built-in Master—Slave operation mode PID 'Sleep' mode Energy Optimising Function	



**OPTIDRIVE PLUS 3<sup>GV</sup> Electrical Data in kW**

200–240V 1 Phase	Motor Power (kW)	Output Current (A)	Frame Size
ODP-12037-IN	0.37	2.3	1
ODP-12075-IN	0.75	4.3	1
ODP-12150-IN	1.5	7	1
ODP-22150-IN	1.5	7	2
ODP-22220-IN	2.2	10.5	2

200–240V 3 Phase	Motor Power (kW)	Output Current (A)	Frame Size
ODP3-22150-IN	1.5	7	2
ODP3-22220-IN	2.2	10.5	2
ODP-32030-IN	3	14	3
ODP-32040-IN	4	18	3
ODP-32055-IN	5.5	25	3
ODP-42075-IN	7.5	39	4
ODP-42110-IN	11	46	4
ODP-42150-IN	15	61	4
ODP-42185-IN	18.5	72	4
ODP-52220-IN	22	90	5
ODP-52300-IN	30	110	5
ODP-52370-IN	37	150	5
ODP-52450-IN	45	180	5
ODP-62055-IN	55	202	6
ODP-62075-IN	75	240	6
ODP-62090-IN	90	300	6

**Note:** Suitable for use on single phase supply with 50% derating

380–480V 3 Phase	Motor Power (kW)	Output Current (A)	Frame Size
ODP-24075-IN	0.75	2.2	2
ODP-24150-IN	1.5	4.1	2
ODP-24220-IN	2.2	5.8	2
ODP-24400-IN	4	9.5	2
ODP-34055-IN	5.5	14	3
ODP-34075-IN	7.5	18	3
ODP-34110-IN	11	25	3
ODP-34150-IN	15	30	3
ODP-44185-IN	18.5	39	4
ODP-44220-IN	22	46	4
ODP-44300-IN	30	61	4
ODP-44370-IN	37	72	4
ODP-44450-IN#	45	90	4
ODP-54450-IN	45	90	5
ODP-54550-IN	55	110	5
ODP-54750-IN	75	150	5
ODP-54900-IN	90	180	5
ODP-64110-IN	110	202	6
ODP-64132-IN	132	240	6
ODP-64160-IN	160	300	6

**Note:** Suitable for use on single phase supply with 50% derating; # Drive has 110% overload for 60 secs

480–525V 3 Phase	Motor Power (kW)	Output Current (A)	Frame Size
ODP-55550-IN	55	90	5
ODP-55750-IN	75	110	5
ODP-55900-IN	90	150	5
ODP-65132-IN	132	202	6
ODP-65160-IN	160	240	6
ODP-65200-IN	200	270	6

**Note:** Not UL Approved

500–600V 3 Phase	Motor Power (kW)	Output Current (A)	Frame Size
ODP-25075-IN*	0.75	1.7	2
ODP-25150-IN*	1.5	3.1	2
ODP-25220-IN*	2.2	4.1	2
ODP-25370-IN*	3.7	6.1	2
ODP-25550-IN*	5.5	9	2
ODP-35075-IN	7.5	14	3
ODP-35110-IN	11	18	3
ODP-35150-IN	15	24	3
ODP-45220-IN	22	39	4
ODP-45300-IN	30	46	4
ODP-45450-IN	45	62	4

\* Requires External Input Choke

**OPTIDRIVE PLUS 3<sup>GV</sup> Electrical Data in HP**

200–240V 1 Phase	Motor Power (HP)	Output Current (A)	Frame Size
ODP-12005-USA	0.5	2.3	1
ODP-12010-USA	1	4.3	1
ODP-12020-USA	2	7	1
ODP-22020-USA	2	7	2
ODP-22030-USA	3	10.5	2

200–240V 3 Phase	Motor Power (HP)	Output Current (A)	Frame Size
ODP3-22020-USA	2	7	2
ODP3-22030-USA	3	10.5	2
ODP-32040-USA	4	14	3
ODP-32050-USA	5	18	3
ODP-32075-USA	7.5	25	3
ODP-42100-USA	10	39	4
ODP-42150-USA	15	46	4
ODP-42200-USA	20	61	4
ODP-42250-USA	25	72	4
ODP-52300-USA	30	90	5
ODP-52400-USA	40	110	5
ODP-52500-USA	50	150	5
ODP-52600-USA	60	180	5
ODP-62075-USA	75	202	6
ODP-62100-USA	100	240	6
ODP-62120-USA	120	300	6

**Note:** Suitable for use on single phase supply with 50% derating

380–480V 3 Phase	Motor Power (HP)	Output Current (A)	Frame Size
ODP-24010-USA	1	2.2	2
ODP-24020-USA	2	4.1	2
ODP-24030-USA	3	5.8	2
ODP-24050-USA	5	9.5	2
ODP-34075-USA	7.5	14	3
ODP-34100-USA	10	18	3
ODP-34150-USA	15	25	3
ODP-34200-USA	20	30	3
ODP-44250-USA	25	39	4
ODP-44300-USA	30	46	4
ODP-44400-USA	40	61	4
ODP-44500-USA	50	72	4
ODP-44600-USA#	60	90	4
ODP-54600-USA	60	90	5
ODP-54750-USA	75	110	5
ODP-54100-USA	100	150	5
ODP-54120-USA	150	180	5
ODP-64150-USA	160	202	6
ODP-64175-USA	200	240	6
ODP-64210-USA	250	300	6

**Note:** Suitable for use on single phase supply with 50% derating; # Drive has 110% overload for 60 secs

500–600V 3 Phase	Motor Power (HP)	Output Current (A)	Frame Size
ODP-25010-USA*	1	1.7	2
ODP-25020-USA*	2	3.1	2
ODP-25030-USA*	3	4.1	2
ODP-25050-USA*	5	6.1	2
ODP-25075-USA*	7.5	9	2
ODP-35100-USA	10	14	3
ODP-35150-USA	15	18	3
ODP-35200-USA	20	24	3
ODP-45300-USA	30	39	4
ODP-45400-USA	40	46	4
ODP-45600-USA	60	62	4

\* Requires External Input Choke

Size 1

Size 2

Size 3

Size 4

Size 5

Size 6



**OPTIDRIVE PLUS 3<sup>GV</sup> Dimensions**

Size	Height (mm)	Width (mm)	Depth (mm)	Weight (kg)	Fixings
1	155	80	130	1.1	2 × M4
2	260	100	175	2.6	2 × M4
3	260	171	175	5.3	4 × M4
4	520	340	220	28	4 × M8
5 (90 – 150A)	1045	340	220	67	4 × M8
5 (180A)	1045	340	330	67	4 × M8
6*	1100	340	330	55	4 × M8

\* Supplied with External Input Choke

**OPTIDRIVE 3<sup>GV</sup> Part Number Designation**

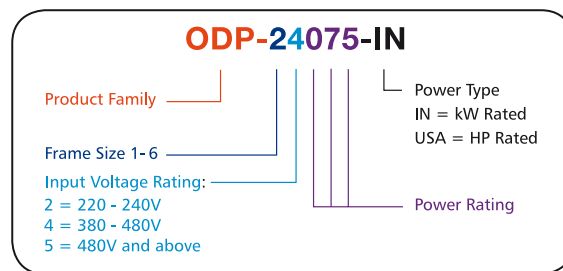

**Options**

Product	Description	Page
OptiFilter	RFI Line Filter	20
Optibrake	Dynamic Braking Resistor	21
Input Chokes	Mains Supply Input Chokes	22
Output Filters	Motor Output Filter, recommended for long motor cable runs	23
3ROUT	3 Relay Output Option	24
2ROUT	2 Relay Output Option	24
HVACO	2 Relay Output for HVAC operation	24
LOGIP	High Voltage Logic Input Option	24
Encoder	Closed loop speed feedback module	25
Optiport Plus	Optiport Plus remote mounting keypad	26
Network Cables	RJ11 Cables and Splitters	27
PC Connection Kit	Isolated RS485 USB Adaptor	27
Optiwand PDA / SP	Commissioning and backup software for Pocket PC / PDA	28
Optistore V3	Commissioning and Storage Software for PC	29
Fieldbus Gateway	DeviceNet, Profibus and Ethernet gateways	30

# OPTIDRIVE VTC

## Variable Torque Control

AC Variable Speed Drive  
1.5kW – 160kW (2.0 – 250HP)  
200 – 600V

Dedicated to the control of fans and pumps

Optidrive VTC provides ease of use plus simple installation and commissioning, making it the lowest cost solution for virtually all variable torque applications.

Innovative and compact the Optidrive VTC range combines good looks with robustness, reliability and effortless performance.

Energy saving is maximised using the sleep mode and the automatic energy optimiser function, which reduces the motor voltage to match the load.

Coherent operation using a unified control interface across the entire range and with only 14 standard parameters to adjust, Optidrive's legendary ease of use could not be easier or quicker to get started with. For the more advanced user the extended parameter set gives access to powerful additional functionality.

Optidrive VTC's optical interface allows communication with the unique Optiwand PDA for fast and accurate product configuration.



### Key Benefits

- Retains footprint, terminal layout and core parameter set of Optidrive Plus 3<sup>GV</sup> for fast installation and set up, a true evolution of the range
- Designed for centrifugal fan and pump applications with dedicated variable torque control
- Up to 50°C Ambient Temperature, rugged design for harsh environments
- Internal RFI Filter for compliance with the latest EMC standards
- Energy optimizing function provides best possible efficiency and energy savings in real time
- Bi-directional Spin Start function allows rapid start and control of fans, even when already turning
- Built-in PI controller for easy control of flow / pressure
- Programmable 'Sleep & Wake Up' modes stops the drive operating when not required, with fully automatic restart
- Built-in Modbus RTU for easy connection to high level networks
- Intelligent fire mode
- Built-in Master—Slave control function with fast set up and selectable scaling
- Built-in Infra Red programming port requires no cables

### Industry Sectors

- Food Processing
- Bottling
- Pumping
- Chemical
- Waste Water
- HVAC





Specification		OPTIDRIVE VTC	
Output Ratings	Overload capacity	110% for 60 secs; 125% for 2 secs	
	Frequency	0...120Hz	
Input Ratings	Frequency	48–62Hz	
	Voltage	200–240V ± 10% 1 Phase (1.5–22kW / 2–30 HP) 200–240V ± 10% 3 Phase (1.5–45kW / 2–60 HP) 380–480V ± 10% 1 Phase (0.75–90kW / 1–105 HP) 380–480V ± 10% 3 Phase (1.5–160kW / 2–250 HP) 480–525V ± 10% 3 Phase (55–200kW) 500–600V ± 10% 3 Phase (1.5–45kW / 2–60 HP)	
Ambient Conditions	Temperature	Operating: -10 to 50°C max; Storage: -40 to 60°C	
	Altitude	0–2000m (derate 5% per 100m above 1000m)	
	Ingress protection	IP20	
Programming	Keypad	Yes	
	PC	Yes	
	PDA	Yes	
Control Specification	Control method	V / F	
	PWM Frequency	4...32kHz (effective)	
	V/Hz ratio	Parabolic	
	Boost	Automatic after autotune	
	Stop mode	Coast/Ramp/DC Brake	
	Internal brake transistor	Yes; External resistor required	
	Capacity	100% Drive Rated Power continuously	
	Skip frequency	One point, adjustable frequency band	
	Frequency setpoint control	0...10V DC	
		± 10V DC	
		0...24V DC	
		4...20mA	
		0...20mA	
		Digital – Keypad	
		RS485 (Master Slave)	
	Modbus RTU		
Preset speeds	8		
PI control	Yes		
Spin start	Yes		
Acceleration	0...3000 secs		
Deceleration	(2 ramps) 0...3000 secs		
PC setup software	Optistore V3		
Programmable I/O	Input 1	Programmable Digital Input	
	Input 2 / Output 2	User-selectable Digital Input / Output	
	Input 3	User-selectable Unipolar Analogue / Digital Input	
	Input 4	User-selectable Bipolar Analogue / Digital Input	
	Output 1	Programmable Analogue / Digital Output	
	Relay 1	Relay Output (30V DC 5A, 250V AC 6A)	
Keypad Display	Operating display	Output Frequency, Current, RPM, Power and User Scalable values	
	Remote mount	Optional Optiport Plus remote mounting keypad	
Protective Functions	Inverter trip	Over voltage, over current, under voltage, external trip, motor overload, over temperature, short circuited, earth fault	
	Memory	Last 4 trips stored	
Bus Communication	Modbus RTU	Standard	
	Profibus DP	via Gateway	
	DeviceNet	via Gateway	
	RS485 (Optibus)	Standard	
Standards Compliance	EN 61800-3:2004	Adjustable speed electrical power drive systems. EMC requirements.	
Additional Features		Built-in Master—Slave operation mode PID 'Sleep & Wake Up' modes Energy Optimising Function	



**OPTIDRIVE VTC Electrical Data in kW**

200–240V 1 Phase	Motor Power (kW)	Output Current (A)	Frame Size
ODV-22150-IN	1.5	7	2
ODV-22220-IN	2.2	10.5	2

200–240V 3 Phase	Motor Power (kW)	Output Current (A)	Frame Size
ODV3-22150-IN	1.5	7	2
ODV3-22220-IN	2.2	10.5	2
ODV-32030-IN	3	14	3
ODV-32040-IN	4	18	3
ODV-32055-IN	5.5	25	3
ODV-42075-IN	7.5	39	4
ODV-42110-IN	11	46	4
ODV-42150-IN	15	61	4
ODV-42185-IN	18.5	72	4
ODV-42220-IN	22	90	4
ODV-52300-IN	30	110	5
ODV-52370-IN	37	150	5
ODV-52450-IN	45	180	5

Note: Suitable for use on single phase supply with 50% derating

380–480V 3 Phase	Motor Power (kW)	Output Current (A)	Frame Size
ODV-24150-IN	1.5	4.1	2
ODV-24220-IN	2.2	5.8	2
ODV-24400-IN	4	9.5	2
ODV-34055-IN	5.5	14	3
ODV-34075-IN	7.5	18	3
ODV-34110-IN	11	25	3
ODV-34150-IN	15	30	3
ODV-44185-IN	18.5	39	4
ODV-44220-IN	22	46	4
ODV-44300-IN	30	61	4
ODV-44370-IN	37	72	4
ODV-44450-IN	45	90	4
ODV-54550-IN	55	110	5
ODV-54750-IN	75	150	5
ODV-54900-IN	90	180	5
ODV-64110-IN	110	202	6
ODV-64132-IN	132	240	6
ODV-64160-IN	160	300	6

Note: Suitable for use on single phase supply with 50% derating

480–525V 3 Phase	Motor Power (kW)	Output Current (A)	Frame Size
ODV-55550-IN	55	110	5
ODV-55750-IN	75	150	5
ODV-55900-IN	90	180	5
ODV-65132-IN	132	202	6
ODV-65160-IN	160	240	6
ODV-65200-IN	200	270	6

Note: Not UL Approved

500–600V 3 Phase	Motor Power (kW)	Output Current (A)	Frame Size
ODV-25150-IN*	1.5	3.1	2
ODV-25220-IN*	2.2	4.1	2
ODV-25370-IN*	3.7	6.1	2
ODV-25550-IN*	5.5	9	2
ODV-35075-IN	7.5	14	3
ODV-35110-IN	11	18	3
ODV-35150-IN	15	24	3
ODV-45220-IN	22	39	4
ODV-45300-IN	30	46	4
ODV-45450-IN	45	62	4

\* Requires External Input Choke

**OPTIDRIVE VTC Electrical Data in HP**

200–240V 1 Phase	Motor Power (HP)	Output Current (A)	Frame Size
ODV-22020-USA	2	7	2
ODV-22030-USA	3	10.5	2

200–240V 3 Phase	Motor Power (HP)	Output Current (A)	Frame Size
ODV3-22020-USA	2	7	2
ODV3-22030-USA	3	10.5	2
ODV-32040-USA	4	14	3
ODV-32050-USA	5	18	3
ODV-32075-USA	7.5	25	3
ODV-42100-USA	10	39	4
ODV-42150-USA	15	46	4
ODV-42200-USA	20	61	4
ODV-42250-USA	25	72	4
ODV-42300-USA	30	90	4
ODV-52400-USA	40	110	5
ODV-52500-USA	50	150	5
ODV-52600-USA	60	180	5

Note: Suitable for use on single phase supply with 50% derating

380–480V 3 Phase	Motor Power (HP)	Output Current (A)	Frame Size
ODV-24020-USA	2	4.1	2
ODV-24030-USA	3	5.8	2
ODV-24050-USA	5	9.5	2
ODV-34075-USA	7.5	14	3
ODV-34100-USA	10	18	3
ODV-34150-USA	15	25	3
ODV-34200-USA	20	30	3
ODV-44250-USA	25	39	4
ODV-44300-USA	30	46	4
ODV-44400-USA	40	61	4
ODV-44500-USA	50	72	4
ODV-44600-USA	60	90	4
ODV-54750-USA	75	110	5
ODV-54100-USA	100	150	5
ODV-54120-USA	150	180	5
ODV-64150-USA	160	202	6
ODV-64175-USA	200	240	6
ODV-64210-USA	250	300	6

Note: Suitable for use on single phase supply with 50% derating

500–600V 3 Phase	Motor Power (HP)	Output Current (A)	Frame Size
ODV-25020-USA*	2	3.1	2
ODV-25030-USA*	3	4.1	2
ODV-25050-USA*	5	6.1	2
ODV-25075-USA*	7.5	9	2
ODV-35100-USA	10	14	3
ODV-35150-USA	15	18	3
ODV-35200-USA	20	24	3
ODV-45300-USA	30	39	4
ODV-45400-USA	40	46	4
ODV-45600-USA	60	62	4

\* Requires External Input Choke

Size 2

Size 3

Size 4

Size 5

Size 6



### OPTIDRIVE VTC Dimensions

Size	Height (mm)	Width (mm)	Depth (mm)	Weight (kg)	Fixings
2	260	100	175	2.6	2 × M4
3	260	171	175	5.3	4 × M4
4	520	340	220	28	4 × M8
5 (90 – 150A)	1045	340	220	67	4 × M8
5 (180A)	1045	340	330	67	4 × M8
6*	1100	340	330	55	4 × M8

\* Supplied with External Input Choke

### OPTIDRIVE VTC Part Number Designation

**ODV-22150-IN**

Product Family

Frame Size 1-6

Input Voltage Rating:  
2 = 220 - 240V  
4 = 380 - 480V  
5 = 480V and above

Power Type

IN = kW Rated

USA = HP Rated

Power Rating



### Options

Product	Description	Page
<b>OptiFilter</b>	RFI Line Filter	20
<b>Optibrake</b>	Dynamic Braking Resistor	21
<b>Input Chokes</b>	Mains Supply Input Chokes	22
<b>Output Filters</b>	Motor Output Filter, recommended for long motor cable runs	23
<b>3ROUT</b>	3 Relay Output Option	24
<b>2ROUT</b>	2 Relay Output Option	24
<b>HVACO</b>	2 Relay Output for HVAC operation	24
<b>LOGIP</b>	High Voltage Logic Input Option	24
<b>Optiport Plus</b>	Optiport Plus remote mounting keypad	26
<b>Network Cables</b>	RJ11 Cables and Splitters	27
<b>PC Connection Kit</b>	Isolated RS485 USB Adaptor	27
<b>Optiwand PDA / SP</b>	Commissioning and backup software for Pocket PC / PDA	28
<b>Optistore V3</b>	Commissioning and Storage Software for PC	29
<b>Fieldbus Gateway</b>	DeviceNet, Profibus and Ethernet gateways	30

# OPTIDRIVE E2

## Ease of Use

AC Variable Speed Drive  
0.37kW – 11kW (0.5 – 15HP)  
110 – 480V

General purpose economy drive with modbus communication

Rich in features the Optidrive E2 is the most commercially competitive Optidrive in the Optidrive family. Innovative and compact the Optidrive E2 range combines good looks with robustness, reliability and easy to use performance.

The product is dedicated to low power applications where total costs are ultra-competitive, including:

- Competitive purchase price
- Low installation costs
- Low commissioning costs
- Low technical support costs

Optidrive E2 has only 14 standard parameters to adjust in its basic form, thus Optidrive's legendary ease of use could not be easier or quicker to get started with. Optidrive E2 can be supplied with or without an internal rfi filter.

### Key Benefits

- Small mechanical envelope
- Rugged industrial 50°C ambient rating for hot and tough applications
- Simple mechanical & electrical installation
- Simple operation, powerful features easy to use
- Fast setup, factory default settings ok for most applications, only 14 basic parameters
- Motor current and rpm indication
- Debugging using troubleshooting & P-00
- 150% overload for 60 secs (175% for 2 secs)
- Keypad control
- Integral RFI filter option
- Integral brake chopper (S2 and S3 only)
- Modbus RTU serial communications



### Industry Sectors

- Food Processing
- Bottling
- Pumping
- Chemical
- Waste Water
- HVAC
- Conveyor



## OPTISTICK Product code: OPT-STICK

For fast and accurate repeat drive programming

Simply insert Optistick into the RJ45 slot on the face of the Optidrive E2:

- Upload/download buttons allow for fast copying of parameters between drives
- Infra red communications capability provides remote control convenience
- Can be programmed with PDA or Smartphone

Specification		OPTIDRIVE E2	
Output Ratings	Overload capacity	150% for 60 secs; 175% for 2 secs	
	Frequency	0...500Hz	
Input Ratings	Frequency	48–62Hz	
	Voltage	110–115V ± 10% 1 Phase (0.5–1.5 HP) 200–240V ± 10% 1 Phase (0.37–4kW / 0.5–5 HP) 200–240V ± 10% 3 Phase (0.37–3.7kW / 0.5–5 HP) 380–480V ± 10% 3 Phase (0.75–11kW / 1–15 HP)	
Ambient Conditions	Temperature	Operating: -10 to 50°C max; Storage: -40 to 60°C	
	Altitude	0–2000 m (derate 1% per 100m above 1000m)	
	Ingress protection	IP20; Optional IP55/NEMA 12 & IP66/NEMA 4X	
Programming	Keypad	Yes	
	PC	Yes	
	PDA	Yes	
	Smartphone	Yes	
Control Specification	Control method	Voltage Vector	
	PWM Frequency	4...32kHz (effective)	
	V/Hz ratio	Linear	
	Boost	Yes	
	Stop mode	Coast/Ramp/DC Brake	
	Internal brake transistor	Yes (sizes 2 and 3); External resistor required	
	Capacity	100% Drive Rated Power continuously	
	Skip frequency	One point, adjustable frequency band	
	Frequency setpoint control	0...10V DC	
		20...4mA	
		4...20mA	
		0...20mA	
		Digital–Keypad Modbus RTU	
	Preset speeds	4	
	PI control	Yes	
	Spin start	Yes	
Acceleration	0...600 secs		
Deceleration	(2 ramps) 0...600 secs		
PC setup software	Optistore V3		
Programmable I/O	Input 1	Programmable Digital Input	
	Input 2	Programmable Digital Input	
	Input 3	User-selectable Analogue / Digital Input	
	Input 4	User-selectable Analogue / Digital Input	
	Output 1	Programmable Analogue / Digital Output	
	Relay 1	Relay Output (30V DC 5A, 250V AC 6A)	
Keypad Display	Operating display	Output Frequency, Current, RPM, Power and User Scalable values	
	Remote mount	Optional Optiport E2 remote mounting keypad	
Protective Functions	Inverter trip	Over voltage, over current, under voltage, external trip, motor overload, over temperature, short circuited, earth fault	
	Memory	Last 4 trips stored	
Bus Communication	Modbus RTU	Standard	
	Profibus DP	via Gateway	
	DeviceNet	via Gateway	
	RS485 (Optibus)	Standard	
Standards Compliance	EN 61800-3:2004	Adjustable speed electrical power drive systems. EMC requirements.	



### OPTIDRIVE E2 Electrical Data in kW with internal rfi filter

200–240V 1 Phase	Motor Power (kW)	Output Current (A)	Frame Size
ODE-2-12037-1KB12	0.37	2.3	1
ODE-2-12075-1KB12	0.75	4.3	1
ODE-2-12150-1KB12	1.5	7	1
ODE-2-22150-1KB42	1.5	7	2
ODE-2-22220-1KB42	2.2	10.5	2
ODE-2-32040-1KB42	4	16	3

200–240V 3 Phase	Motor Power (kW)	Output Current (A)	Frame Size
ODE-2-12037-3K012#	0.37	2.3	1
ODE-2-12075-3K012#	0.75	4.3	1
ODE-2-12150-3K012#	1.5	7	1
ODE-2-22150-3KB42	1.5	7	2
ODE-2-22220-3KB42	2.2	10.5	2
ODE-2-32040-3KB42	4	18	3

**Note:** Suitable for use on single phase supply with 50% derating  
# Size 1, 3 Phase Input drives are not available with internal rfi filter

380–480V 3 Phase	Motor Power (kW)	Output Current (A)	Frame Size
ODE-2-14075-3KA12	0.75	2.2	1
ODE-2-14150-3KA12	1.5	4.1	1
ODE-2-24150-3KA42	1.5	4.1	2
ODE-2-24220-3KA42	2.2	5.8	2
ODE-2-24400-3KA42	4	9.5	2
ODE-2-34055-3KA42	5.5	14	3
ODE-2-34075-3KA42	7.5	18	3
ODE-2-34110-3KA42	11	24	3

### OPTIDRIVE E2 Electrical Data in HP without internal rfi filter

110–115V 1 Phase	Motor Power (HP)	Output Current (A)	Frame Size
ODE-2-11005-1H012	0.5	2.3	1
ODE-2-11010-1H012	1	4.3	1
ODE-2-21015-1H042	1.5	5.8	2

**Note:** 230V, 3 phase output (Voltage Doubler)

200–240V 1 Phase	Motor Power (HP)	Output Current (A)	Frame Size
ODE-2-12005-1H012	0.5	2.3	1
ODE-2-12010-1H012	1	4.3	1
ODE-2-12020-1H012	2	7	1
ODE-2-22020-1H042	2	7	2
ODE-2-22030-1H042	3	10.5	2
ODE-2-32050-1H042	5	16	3

200–240V 3 Phase	Motor Power (HP)	Output Current (A)	Frame Size
ODE-2-12005-3H012	0.5	2.3	1
ODE-2-12010-3H012	1	4.3	1
ODE-2-12020-3H012	2	7	1
ODE-2-22020-3H042	2	7	2
ODE-2-22030-3H042	3	10.5	2
ODE-2-32050-3H042	5	18	3

**Note:** Suitable for use on single phase supply with 50% derating

380–480V 3 Phase	Motor Power (HP)	Output Current (A)	Frame Size
ODE-2-14010-3H012	1	2.2	1
ODE-2-14020-3H012	2	4.1	1
ODE-2-24020-3H042	2	4.1	2
ODE-2-24030-3H042	3	5.8	2
ODE-2-24050-3H042	5	9.5	2
ODE-2-34075-3H042	7.5	14	3
ODE-2-34100-3H042	10	18	3
ODE-2-34150-3H042	15	24	3

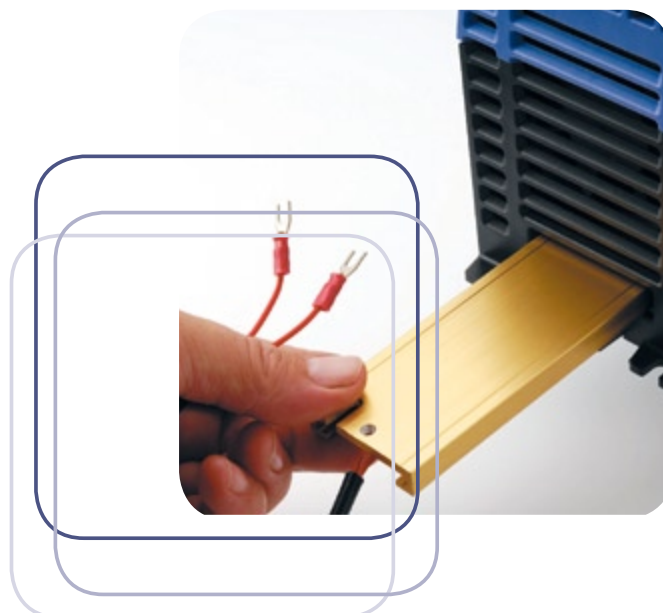



**OPTIDRIVE E2 Dimensions**

Size	Height (mm)	Width (mm)	Depth (mm)	Weight (kg)	Fixings
1	173	82	123	1.1	4 × M4
2	221	104	150	2.6	4 × M4
3	261	131	175	4.0	4 × M4



**OPTIDRIVE E2 Part Number Designation**

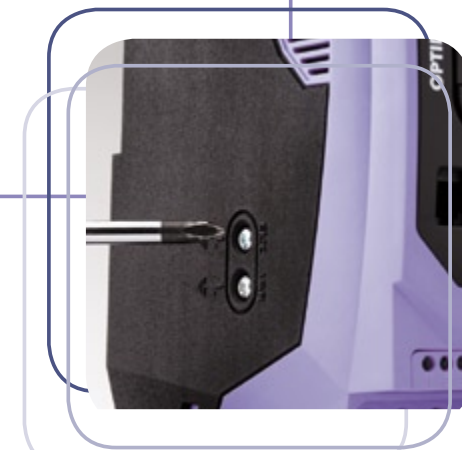
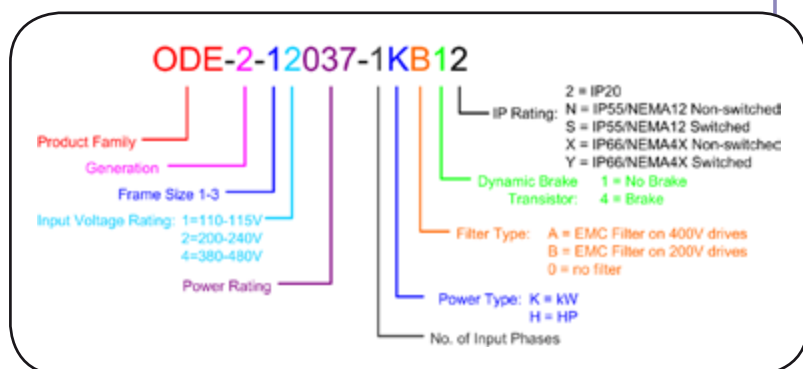

*EMC and Varistor disconnect*

**Options**

Product	Description	Page
OptiFilter	RFI Line Filter	20
Optibrake	Dynamic Braking Resistor	21
Input Chokes	Mains Supply Input Chokes	22
Output Filters	Motor Output Filter, recommended for long motor cable runs	23
2ROUT	2 Relay Output Option	24
HVACO	2 Relay Output for HVAC operation	24
LOGIP	High Voltage Logic Input Option	24
Optiport E2	Optiport Plus remote mounting keypad	26
Network Cables	RJ45 Cables and Splitters	27
PC Connection Kit	Isolated RS485 USB Adaptor	27
Optiwand PDA / SP	Commissioning and backup software for Pocket PC / PDA	28
Optistore V3	Commissioning and Storage Software for PC	29
Fieldbus Gateway	DeviceNet, Profibus and Ethernet gateways	30

# OPTIDRIVE E2 SINGLE PHASE

## Single Phase Motor Control

AC Variable Speed Drive  
0.37kW – 11kW (0.5 – 15HP)  
110 – 240V

Variable speed drive for low power single phase motors

The Optidrive E2 Single Phase is the World's first fully digital, fully packaged variable speed drive for controlling low power single phase motors.

Designed to be cost effective and easy to use, the Optidrive E2 Single Phase is for use with PSC (Permanent Split Capacitor) or Shaded-Pole Single-Phase induction motors.

Optidrive E2 Single Phase uses a revolutionary motor control strategy to achieve reliable intelligent starting of single phase motors.

Optidrive E2 Single Phase has only 14 standard parameters to adjust in its basic form. The Optidrive's legendary ease of use ensures quick and easy drive commissioning. For the more advanced user the extended parameter set gives access to powerful additional functionality.

### Typical Applications

Direct-drive fans and blowers with PSC (permanent-split capacitor) and shaded pole motors on single-phase power. These are typically applications with a starting torque of between 50 – 100% of motor full load rated torque.

### Key Benefits

- 115V & 220V ratings
- Single phase input / single phase output
- Small mechanical envelope
- Rugged industrial operation 50°C ambient rating
- Simple mechanical & electrical installation
- Fast setup, and simple operation. Factory default settings okay for most applications, only 14 basic parameters
- Variable torque or constant torque
- Unique programmable boost feature to achieve intelligent starting
- Motor current and rpm indication
- Debugging using troubleshooting & P-00
- 150% overload for 60 secs (175% for 2 secs)
- Keypad control
- Integral RFI filter option
- Integral brake chopper (S2 only)
- Modbus RTU serial communications



### Industry Sectors

- Fan Control
- Food Processing
- Pumping
- Waste Water



### OPTIDRIVE E2 SINGLE PHASE Dimensions

Size	Height (mm)	Width (mm)	Depth (mm)	Weight (kg)	Fixings
1	173	82	123	1.1	4 × M4
2	221	104	150	2.6	4 × M4



Specification		OPTIDRIVE E2 SINGLE PHASE	
Output Ratings	Overload capacity	150% for 60 secs; 175% for 2 secs	
	Frequency	0...120Hz	
Input Ratings	Frequency	48–62Hz	
	Voltage	110–115V ± 10% 1 Phase (0.5–1.5HP) 200–240V ± 10% 1 Phase (0.37–1.1kW / 0.5–1.5HP)	
Ambient Conditions	Temperature	Operating: -10 to 50°C max; Storage: -40 to 60°C	
	Altitude	0–2000m (derate 1% per 100m above 1000m)	
	Ingress protection	IP20; Optional IP55/NEMA 12 & IP66/NEMA 4X	
Programming	Keypad	Yes	
	PDA	Yes	
	Smartphone	Yes	
Control Specification	Control method	V / F	
	V/Hz ratio	Linear	
	Boost	Automatic Boost Phase Operation	
	Stop mode	Coast/Ramp/DC Brake	
	Internal brake transistor	Yes (size 2 only); External resistor required	
	Capacity	100% Drive Rated Power continuously	
	Frequency setpoint control	0...10V DC	
		0...24V DC	
		4...20mA	
		0...20mA	
		Digital–Keypad Modbus RTU	
	Preset speeds	4	
	PI control	Yes	
Spin start	Yes		
Acceleration	0...600 secs		
Deceleration	(2 ramps) 0...600 secs		
PC setup software	Optistore V3		
Programmable I/O	Input 1	Programmable Digital Input	
	Input 2 / Output 2	User-selectable Digital Input / Output	
	Input 3	User-selectable Analogue / Digital Input	
	Input 4	User-selectable Analogue / Digital Input	
	Output 1	Programmable Analogue / Digital Output	
	Relay 1	Relay Output (30V DC 5A, 250V AC 6A)	
Keypad Display	Operating display	Output Frequency, Current, RPM and User Scalable values	
	Remote mount	Optional Optiport E2 remote mounting keypad	
Protective Functions	Inverter trip	Over voltage, over current, under voltage, external trip, motor overload, over temperature, short circuited, earth fault	
	Memory	Last 4 trips stored	
Bus Communication	Modbus RTU	Standard	
	Profibus DP	via Gateway	
	DeviceNet	via Gateway	
	RS485 (Optibus)	Standard	

## SPECIAL BOOST PHASE OPERATION

To ensure reliable starting, the Optidrive E2 initially ramps the motor voltage up to rated voltage whilst maintaining a fixed starting frequency, before reducing the frequency and voltage to the desired operating point, see diagrams below.

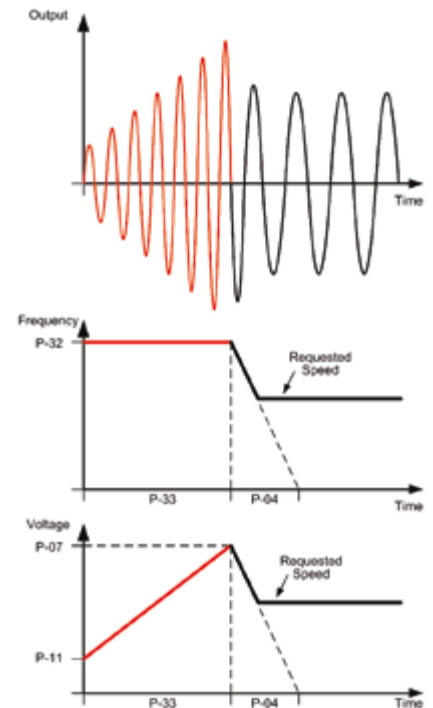

## Electrical Data in kW

with rfi filter fitted

200–240V 1 Phase	Motor Power (kW)	Output Current (A)	Frame Size
ODE-2-12037-1KB1#-01	0.37	4.3	1
ODE-2-12075-1KB1#-01	0.75	7	1
ODE-2-22110-1KB4#-01	1.1	10.5	2

## Electrical Data in HP

without rfi filter fitted

110–115V 1 Phase	Motor Power (HP)	Output Current (A)	Frame Size
ODE-2-11005-1H01#-01	0.5	7	1
ODE-2-21007-1H04#-01	0.75	10.5	2

200–240V 1 Phase	Motor Power (HP)	Output Current (A)	Frame Size
ODE-2-12005-1H01#-01	0.5	4.3	1
ODE-2-12010-1H01#-01	1	7	1
ODE-2-22015-1H04#-01	1.5	10.5	2

**Note:** Substitute the # for the appropriate IP / NEMA rated product identifier.

Full product details and model numbers can be found online at [www.invertek.co.uk](http://www.invertek.co.uk)

## OPTIDRIVE E2 SINGLE PHASE Part Number Designation

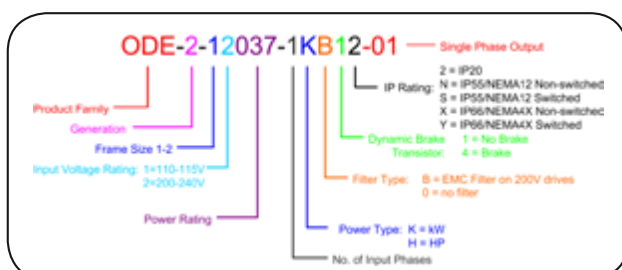

For Options, please refer to page 13

# ENCLOSED OPTIDRIVE IP55 / NEMA 12

## Washdown Duty

AC Variable Speed Drive  
0.37kW – 7.5kW (0.5 – 10HP)  
110 – 600V

The ultimate drive for harsh environments. The IP55 / NEMA 12 enclosure drive has been designed to expand the success of the Optidrive E2 and Optidrive Plus 3<sup>GV</sup> product range

### Key Benefits

- Washdown duty IP55 / NEMA 12
- Wall mountable
- Resists low-pressure water, dust, dirt and chemicals
- Rugged industrial 40°C ambient rating for hot and tough applications
- Conduit cable entry
- Switched or non switched
- Infra red capability
- Keypad Control
- Integral RFI filter option
- Small mechanical size

### Switched Units

- Local Power Isolater
- Local Potentiometer for speed control
- Drive REV/OFF/FWD switch

### Ratings Explained

**IP55:** The IP55 rating means this unit has a protection level of five against solid-body ingress, and a protection level of five against the ingress of water. Five is the second-highest protection level against solid bodies, meaning the unit is protected against dust ingress to the point of disallowing harmful deposits. Protection against water ingress goes up to level eight, and a five means this unit will be protected against the effects of low-pressure jets of water from any direction.

**NEMA 12:** Type 12 enclosures are intended for industrial indoor use primarily to provide a degree of protection against dust, falling dirt, and dripping noncorrosive liquids.



### Industry Sectors

- Food Processing
- Bottling
- Pumping
- Chemical
- Waste Water
- HVAC
- Conveyors



Size 1  
Non-Switched



Size 2  
Switched



Size 3  
Switched



### OPTIDRIVE IP55 Dimensions

Size	Height (mm)	Width (mm)	Depth (mm)	Weight (kg)	Fixings
1	200	140	162	2.4	2 x M4
2	310	164	176	4.6	4 x M4
3	310	210.5	243	7.4	4 x M4

### OPTIDRIVE E2 IP55 Electrical Data in kW

**Note:** For IP55 drives the # is substituted for N = Non-Switched or S = Switched

200–240V 1 Phase	Motor Power (kW)	Output Current (A)	Frame Size
ODE-2-12037-1KB1#	0.37	2.3	1
ODE-2-12075-1KB1#	0.75	4.3	1
ODE-2-12150-1KB1#	1.5	7	1
ODE-2-22150-1KB4#	1.5	7	2
ODE-2-22220-1KB4#	2.2	10.5	2

200–240V 3 Phase	Motor Power (kW)	Output Current (A)	Frame Size
ODE-2-12037-3KA1#	0.37	2.3	1*
ODE-2-12075-3KA1#	0.75	4.3	1*
ODE-2-12150-3KA1#	1.5	7	1*
ODE-2-22150-3KB4#	1.5	7	2
ODE-2-22220-3KB4#	2.2	10.5	2
ODE-2-32040-3KB4#	4	18	3

**Note:** Suitable for use on single phase supply with 50% derating

\* Size 1 drives are not available with internal rfi filter

380–480V 3 Phase	Motor Power (kW)	Output Current (A)	Frame Size
ODE-2-14075-3KA1#	0.75	2.2	1
ODE-2-14150-3KA1#	1.5	4.1	1
ODE-2-24150-3KA4#	1.5	4.1	2
ODE-2-24220-3KA4#	2.2	5.8	2
ODE-2-24400-3KA4#	4	9.5	2
ODE-2-34055-3KA4#	5.5	14	3
ODE-2-34075-3KA4#	7.5	18	3

### OPTIDRIVE 3<sup>GV</sup> IP55 Electrical Data in kW

**Note:** For IP55 drives the # is substituted for I55 = Non-Switched or I55S = Switched

200–240V 1 Phase	Motor Power (kW)	Output Current (A)	Frame Size
ODP-12037-IN-#	0.37	2.3	1
ODP-12075-IN-#	0.75	4.3	1
ODP-12150-IN-#	1.5	7	1
ODP-22150-IN-#	1.5	7	2
ODP-22220-IN-#	2.2	10.5	2

200–240V 3 Phase	Motor Power (kW)	Output Current (A)	Frame Size
ODP3-22150-IN-#	1.5	7	2
ODP3-22220-IN-#	2.2	10.5	2

380–480V 3 Phase	Motor Power (kW)	Output Current (A)	Frame Size
ODP-24075-IN-#	0.75	2.2	2
ODP-24150-IN-#	1.5	4.1	2
ODP-24220-IN-#	2.2	5.8	2
ODP-24400-IN-#	4	9.5	2

500–600V 3 Phase	Motor Power (kW)	Output Current (A)	Frame Size
ODP-25075-IN-#*	0.75	1.7	2
ODP-25150-IN-#*	1.5	3.1	2
ODP-25220-IN-#*	2.2	4.1	2
ODP-25370-IN-#*	3.7	6.1	2
ODP-25550-IN-#*	5.5	9	2

\* Requires Input Choke

### OPTIDRIVE E2 IP55 Electrical Data in HP

**Note:** For IP55 drives the # is substituted for N = Non-Switched or S = Switched

110–115V 1 Phase	Motor Power (HP)	Output Current (A)	Frame Size
ODE-2-11005-1H01#	0.5	2.3	1
ODE-2-11010-1H01#	1	4.3	1
ODE-2-21015-1H04#	1.5	5.8	2

**Note:** 230V, 3 phase output (Voltage Doubler)

200–240V 1 Phase	Motor Power (HP)	Output Current (A)	Frame Size
ODE-2-12005-1H01#	0.5	2.3	1
ODE-2-12010-1H01#	1	4.3	1
ODE-2-12020-1H01#	2	7	1
ODE-2-22020-1H04#	2	7	2
ODE-2-22030-1H04#	3	10.5	2

200–240V 3 Phase	Motor Power (HP)	Output Current (A)	Frame Size
ODE-2-12005-3H01#	0.5	2.3	1
ODE-2-12010-3H01#	1	4.3	1
ODE-2-12020-3H01#	2	7	1
ODE-2-22020-3H04#	2	7	2
ODE-2-22030-3H04#	3	10.5	2
ODE-2-32050-3H04#	5	18	3

**Note:** Suitable for use on single phase supply with 50% derating

380–480V 3 Phase	Motor Power (HP)	Output Current (A)	Frame Size
ODE-2-14010-3H01#	1	2.2	1
ODE-2-14020-3H01#	2	4.1	1
ODE-2-24020-3H04#	2	4.1	2
ODE-2-24030-3H04#	3	5.8	2
ODE-2-24050-3H04#	5	9.5	2
ODE-2-34075-3H04#	7.5	14	3
ODE-2-34100-3H04#	10	18	3

### OPTIDRIVE 3<sup>GV</sup> IP55 Electrical Data in HP

**Note:** For IP55 drives the # is substituted for I55 = Non-Switched or I55S = Switched

200–240V 1 Phase	Motor Power (HP)	Output Current (A)	Frame Size
ODP-12005-USA-#	0.5	2.3	1
ODP-12010-USA-#	1	4.3	1
ODP-12020-USA-#	2	7	1
ODP-22020-USA-#	2	7	2
ODP-22030-USA-#	3	10.5	2

200–240V 3 Phase	Motor Power (HP)	Output Current (A)	Frame Size
ODP3-22020-USA-#	2	7	2
ODP3-22030-USA-#	3	10.5	2

380–480V 3 Phase	Motor Power (HP)	Output Current (A)	Frame Size
ODP-24010-USA-#	1	2.2	2
ODP-24020-USA-#	2	4.1	2
ODP-24030-USA-#	3	5.8	2
ODP-24050-USA-#	5	9.5	2

500–600V 3 Phase	Motor Power (HP)	Output Current (A)	Frame Size
ODP-25010-USA-#*	1	1.7	2
ODP-25020-USA-#*	2	3.1	2
ODP-25030-USA-#*	3	4.1	2
ODP-25050-USA-#*	5	6.1	2
ODP-25075-USA-#*	7.5	9	2

\* Requires Input Choke

# OPTIDRIVE IP66 / NEMA 4X

## Washdown Duty

AC Variable Speed Drive  
0.37kW – 7.5kW (0.5 – 10HP)  
110 – 480V



Ideal for high-pressure washdown applications

Ready for high-pressure washdown, the cost-effective IP66 / NEMA 4X Optidrive can be mounted directly on your processing equipment.

Available for all Optidrive E2 variants up to 7.5kW/10HP in three physical frames sizes.

### Key Benefits

- Dust-tight IP66 / NEMA 4X enclosure for protection in dusty and damp environments
- Innovative sealing system to resist frequent high pressure washdown
- Coated heatsink resists corrosion and chemicals
- Simple parameter set for fast commissioning and start up
- Optistick compatible, allowing parameters to be rapidly copied between multiple drives
- Cast heatsink with wide cooling channels to resist blockage negates the need for a cooling fan
- Optional internal EMC filter complies with EN61800-3 requirements
- Built in PI Controller for level, flow or pressure control applications
- Modbus RTU onboard allows simple control and integration with a wide range of PLCs and MMIs

### Switched Units (optional)

- Local Power Isolater
- Local Potentiometer for speed control
- Drive REV/OFF/FWD switch

### Ratings Explained

**IP66:** IP (Ingress Protection) ratings classify the level of protection provided by an enclosure or housing, against solids (1st digit) and liquids (2nd digit). IP66 is rated as 'dust-tight' and protected against 'powerful jets of water'.

**NEMA 4X:** The NEMA (National Electrical Manufacturers Association) ratings can be approximately compared to those of the IP system. NEMA 4X specifies protection against falling dirt, windblown dust, splashing or hose-directed water and corrosion.



### Industry Sectors

- Food Processing
- Paper & Forest Products
- Petroleum & Chemical
- Unit & Baggage Handling
- HVAC
- Pumping & Fluid Handling
- Aggregate & Cement
- Mining



Size 2  
Non-switched

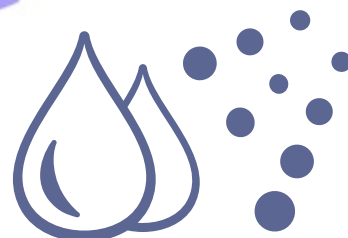

**OPTIDRIVE IP66 / NEMA 4X Electrical Data**
**110–115V ± 10% 1 Phase Input / 3 Phase 230V Output (Voltage Doubler)**

kW Models			HP Models				
With Filter	Without Filter	kW	With Filter	Without Filter	HP	Output Current (A)	Size
–	–	–	–	ODE-2-11005-1H01#	0.5	2.3	1
–	–	–	–	ODE-2-11010-1H01#	1	4.3	1
–	–	–	–	ODE-2-21015-1H04#	1.5	5.8	2

**200–240V ± 10% 1 Phase Input**

kW Models			HP Models				
With Filter	Without Filter	kW	With Filter	Without Filter	HP	Output Current (A)	Size
ODE-2-12037-1KB1#	ODE-2-12037-1K01#	0.37	ODE-2-12005-1HB1#	ODE-2-12005-1H01#	0.5	2.3	1
ODE-2-12075-1KB1#	ODE-2-12075-1K01#	0.75	ODE-2-12010-1HB1#	ODE-2-12010-1H01#	1	4.3	1
ODE-2-12150-1KB1#	ODE-2-12150-1K01#	1.5	ODE-2-12020-1HB1#	ODE-2-12020-1H01#	2	7	1
ODE-2-22150-1KB4#	ODE-2-22150-1K04#	1.5	ODE-2-22020-1HB4#	ODE-2-22020-1H04#	2	7	2
ODE-2-22220-1KB4#	ODE-2-22220-1K04#	2.2	ODE-2-22030-1HB4#	ODE-2-22030-1H04#	3	10.5	2

**200–240V ± 10% 3 Phase Input**

kW Models			HP Models				
With Filter	Without Filter	kW	With Filter	Without Filter	HP	Output Current (A)	Size
–	ODE-2-12037-3K01#	0.37	–	ODE-2-12005-3H01#	0.5	2.3	1
–	ODE-2-12075-3K01#	0.75	–	ODE-2-12010-3H01#	1	4.3	1
–	ODE-2-12150-3K01#	1.5	–	ODE-2-12020-3H01#	2	7	1
ODE-2-22150-3KB4#	ODE-2-22150-3K04#	1.5	ODE-2-22020-3HB4#	ODE-2-22020-3H04#	2	7	2
ODE-2-22220-3KB4#	ODE-2-22220-3K04#	2.2	ODE-2-22030-3HB4#	ODE-2-22030-3H04#	3	10.5	2
ODE-2-32040-3KB4#	ODE-2-32040-3K04#	4.0	ODE-2-32050-3HB4#	ODE-2-32050-3H04#	5	18	3

**380–480V ± 10% 3 Phase Input**

kW Models			HP Models				
With Filter	Without Filter	kW	With Filter	Without Filter	HP	Output Current (A)	Size
ODE-2-14075-3KA1#	ODE-2-14075-3K01#	0.75	ODE-2-14010-3HA1#	ODE-2-14010-3H01#	1	2.2	1
ODE-2-14150-3KA1#	ODE-2-14150-3K01#	1.5	ODE-2-14020-3HA1#	ODE-2-14020-3H01#	2	4.1	1
ODE-2-24150-3KA4#	ODE-2-24150-3K04#	1.5	ODE-2-24020-3HA4#	ODE-2-24020-3H04#	2	4.1	2
ODE-2-24220-3KA4#	ODE-2-24220-3K04#	2.2	ODE-2-24030-3HA4#	ODE-2-24030-3H04#	3	5.8	2
ODE-2-24400-3KA4#	ODE-2-24400-3K04#	4	ODE-2-24050-3HA4#	ODE-2-24050-3H04#	5	9.5	2
ODE-2-34055-3KA4#	ODE-2-34055-3K04#	5.5	ODE-2-34075-3HA4#	ODE-2-34075-3H04#	7.5	14	3
ODE-2-34075-3KA4#	ODE-2-34075-3K04#	7.5	ODE-2-34100-3HA4#	ODE-2-34100-3H04#	10	18	3

All models are available with or without switches.

Note: Replace '#' in the product code with: 'Y' for switched drives or 'X' for non-switched drives.

**OPTIDRIVE IP66 / NEMA 4X Dimensions**

Size	Height (mm)	Width (mm)	Depth (mm)	Weight (kg)	Fixings
1	232	161	175	2.8	4 × M4
2	257	188	187	4.6	4 × M4
3	310	210.5	243	7.4	4 × M4

**Specification**

Output Ratings	Overload capacity	150% for 60 secs; 175% for 2 secs
	Frequency	0...500Hz
Input Ratings	Frequency	48–62 Hz
	Voltage	110–115V ± 10% 1 Phase (0.5–1.5HP) 200–240V ± 10% 1 Phase (0.37–2.2kW / 0.5–3HP) 200–240V ± 10% 3 Phase (0.37–3.7kW / 0.5–5HP) 380–480V ± 10% 3 Phase (0.75–7.5kW / 1–10HP)
	Temperature	Operating: -10 to 40°C max Storage: -40 to 60°C
	Altitude	0–2000m (derate 1% per 100m above 1000m)
	Ingress protection	IP66 / NEMA 4X (indoor use)
Programming	Keypad	Yes
	PC	Yes
	PDA	Yes
	Smartphone	Yes
	Control Specification	Control method
PWM Frequency	4...32kHz (effective)	
V/Hz ratio	Linear	
Boost	Yes	
Stop mode	Coast/Ramp/DC Brake	
Internal brake transistor	Yes (sizes 2 and 3); External resistor required	
Capacity	100% Drive Rated Power continuously	
Skip frequency	One point, adjustable frequency band	
Frequency setpoint control	0...10V DC 20...4mA 4...20mA Digital–Keypad Modbus	
Preset speeds	4	
PI control	Yes	
Spin start	Yes	
Acceleration	0...600 secs	
Deceleration	(2 ramps) 0...600 secs	
Programmable I/O	Input 1, Input 2	Programmable Digital Input
	Input 3, Input 4	User-selectable Analogue / Digital Input
	Output 1	Programmable Analogue / Digital Output
	Relay 1	Relay Output (30V DC 5A, 250V AC, 6A)
Keypad Display	Operating display	Output Frequency, Current, RPM and User Scalable values
	Remote mount	Optional Optoport E2 remote mounting keypad
Protective Functions	Inverter trip	Over voltage, over current, under voltage, external trip, motor overload, over temperature, short circuited, earth fault
	Memory	Last 4 trips stored
Bus Communication	Modbus RTU	Standard
	Profibus DP	via Gateway
	DeviceNet	via Gateway
	RS485 (Optibus)	Standard
Compliance	EN 61800-3:2004	Adjustable speed electrical power drive systems. EMC requirements.

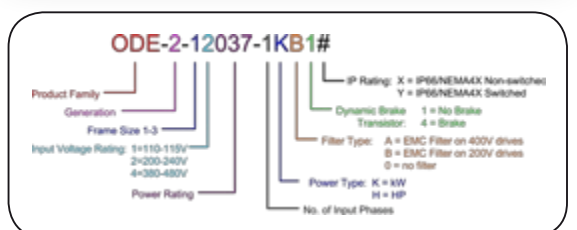

# OPTIFILTER

## RFI Line Filters

Optidrive Size 1, 2 & 3

Footprint or side mounting filters for compliance with EMC standards for conducted emissions

**Note:** All Optidrives inherently comply with the EMC radiated emission standards (EN 61000), when good wiring practice is employed.

Optifilters are mechanically easy to install and to retrofit and the provision of filter-drive cables significantly reduces electrical wiring time.

A key feature of all Optifilters is the predominant use of high specification inductive components rather than lower cost capacitive components. This substantially improves earth leakage performance and is of particular benefit for medical, domestic and multi-drive system applications where earth leakage breakers will trip less readily.

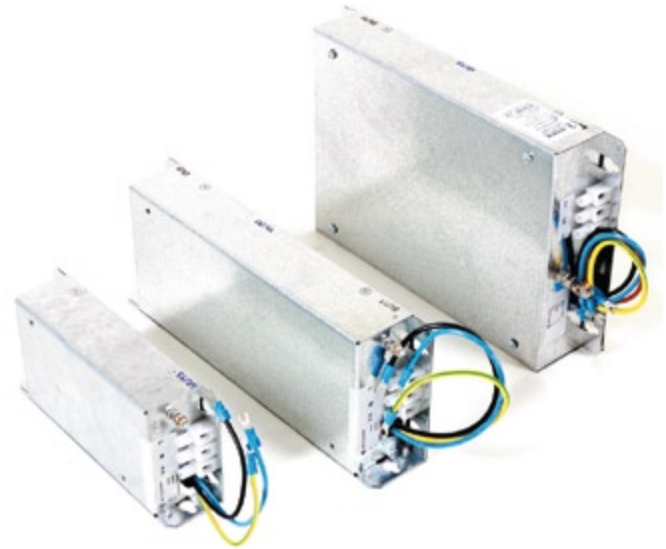

### Specification

Drive Size		1	1	2	2	3
<b>Optifilter model OD-xxxxx</b>		<b>F112I</b>	<b>F134I</b>	<b>F212I</b>	<b>F234I</b>	<b>F334I</b>
Supply voltage $\pm 10\%$	V	220-240	220-480	220-240	220-480	220-480
Phases		1	3	1	3	3
Output current (max)	A	16	6	25	16	30
Earth leakage	mA	<1.6	<30	<1.6	<30	<30
<b>Dimensions:</b>						
W1	mm	90	90	114	114	186.6
W2	mm	65.5	65.5	75.5	75.5	148
W3	mm	54.5	54.5	64.5	64.5	137
W4	mm	60	60	70	70	146.6
h1	mm	200	200	300	300	300
h2	mm	30	30	20	20	20
h3	mm	5.5	5.5	5.5	5.5	6.22
h4	mm	6.5	6.5	6.5	6.5	6.5
d1	mm	175	175	225	225	225
d2	mm	46	46	51	51	51
d3	mm	23	23	25.6	25.6	-
Weight (filter only)	kg	0.5	0.5	0.9	0.9	0.9

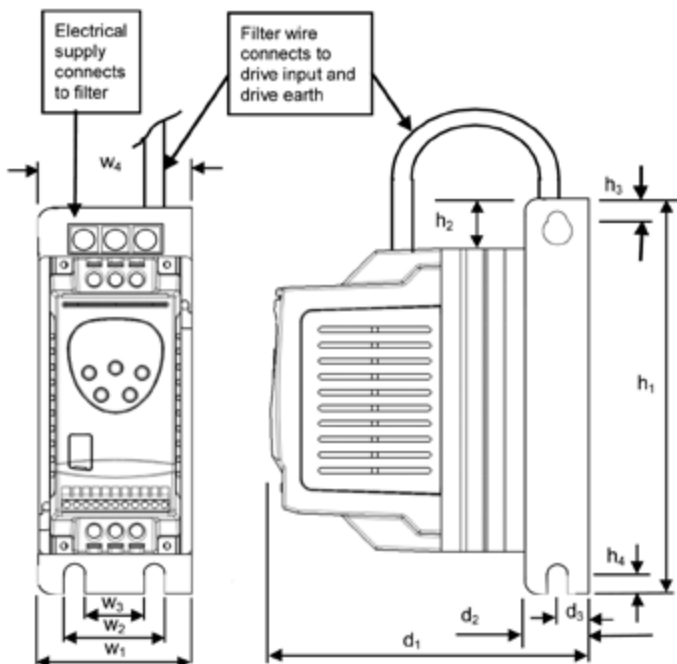

# OPTIBRAKE

## Dynamic Braking Resistors

Optidrive Size 2 to 6

Optibrake dynamic braking resistors are designed specifically for the Optidrive range. For use with high inertia loads which need to be stopped rapidly. Optibrake dynamic braking resistors assist the Optidrive in managing the electrical energy returned from the motor during braking by converting it to heat energy

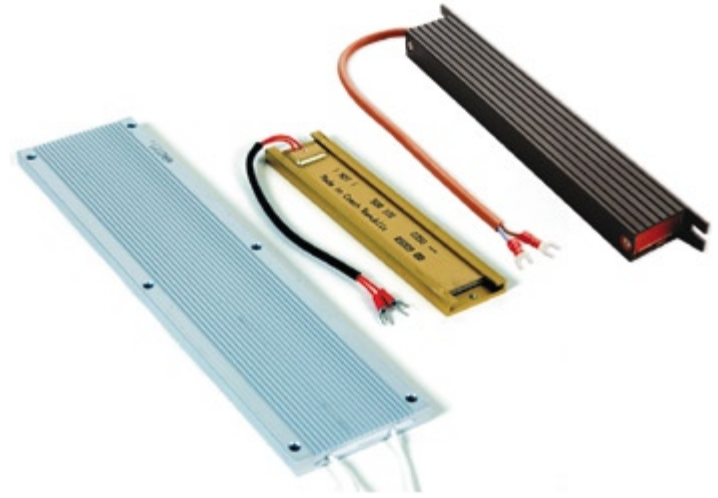

### Key Benefits

- Optidrive software protects the Optibrake from overload, hence no need for expensive overload relays
- Internal fusible element ensures fail safe operation
- Connects to side of drive, using heatsinking properties of heatsink to prevent overheating
- No space envelope penalty, fits on side of drive
- Series/parallel arrangements for more demanding applications

### Key Physical Features

- IP21, robust assembly
- Wirewound
- Metal clad housing
- Internal fuse link protection

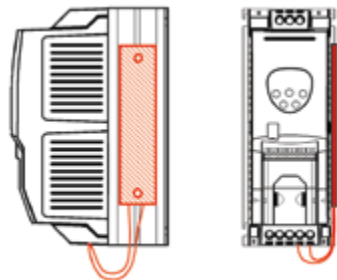

### Specification — IP20

**Part No: OD-BRI00-IN**

**Description:** 100 Ohm, 200W continuous, 12kW peak for 0.125s

**Dimensions:** 188 × 40 × 9mm

**Recommended Drive Size:** Size 2 and 3

**Part No: OD-BRES4-IN**

**Description:** 33 Ohm, 500W continuous, 21kW peak for 0.125s

**Dimensions:** 330 × 80 × 10mm

**Recommended Drive Size:** Size 4, 5 and 6

### Specification — IP55

**Part No: OPT-BR050-IN-I55**

**Description:** 50 Ohm, 200W continuous, 12kW peak for 0.125s

**Dimensions:** 250 × 21 × 40mm

**Recommended Drive Size:** Size 2 and 3

# INPUT CHOKES

Reduce supply harmonic distortion and protect Optidrive against harmful supply disturbances

Most types of drive products create supply harmonic distortion owing to the configuration of the power input circuit. Input chokes are used to reduce the effects of the Optidrive upon supply harmonic distortion (see below).

Input chokes are also used to protect the power input circuits of the Optidrive against voltage spikes which might originate from lightning strikes or other equipment on the same supply. Small power Optidrives are particularly susceptible to this on certain supplies where lightning occurs or if there are other power electronic devices which cause notching on the supply ie welders, dc drives etc.

Input chokes are available for Optidrive size 1, 2 and 3.

Optidrive sizes 4, 5 & 6 include 3 phase line chokes as part of the products basic design, this significantly improves the robustness of these products and is a key specification benefit.

A range of input chokes for 12 pulse systems are available on request.

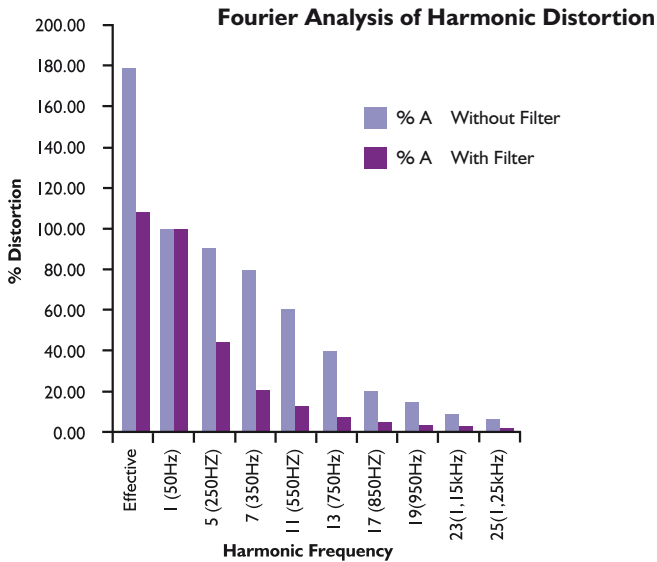

The graph shows the effect of using an input choke on typical 4kW/ 5HP drive. The 50Hz current is used as a reference and is the current which delivers the useful power to the motor. The reduction in the total effective (RMS) current is clear.

## Specification — IP20

Part Number	Optidrive Size	Rated Voltage	Phases	H (mm)	L (mm)	W (mm)	Mass (kg)
OD-IL121-IN	1	<230	1	80	78	78	1.1
OD-IL221-IN	2	<230	1	95	85	80	1.8
OD-IL143-IN	1	<500	3	115	95	65	2.3
OD-IL243-IN	2	<500	3	160	155	105	3.5
OD-IL343-IN	3	<500	3	220	190	80	8.4

## Specification — IP55

Part Number	Optidrive Size	Rated Voltage	Phases	H (mm)	L (mm)	W (mm)	Mass (kg)
OD-IL121-IN-I55	1	<230	1	130	151	85	1.6
OD-IL221-IN-I55	2	<230	1	135	155	85	2.3
OD-IL163-IN-I55	1	<600	3	170	151	85	2.8
OD-IL263-IN-I55	2	<600	3	197	175	99	3.5
OD-IL363-IN-I55*	3	<600	3	197	175	114	7

\* Maximum 5.5kW

**Note:** Dimensions include terminal box and glands where fitted



# OUTPUT FILTERS

Output filters improve the quality of the output waveform

Optidrive, like the majority of other inverter drives have unfiltered outputs. In the majority of applications this will give satisfactory performance, however, in a small number of applications output filtering is strongly recommended to improve system functionality, reliability and longevity.

**These applications include:**

- Long motor cables, up to 200m
- High capacitance motor cables (ie typical “pyro” wire, used for fire protection)
- Multiple motors connected in parallel
- Motors without inverter grade insulation (typically older motors)

**A range of high quality output filters are available for Optidrive with the following key features:**

- Limits output voltage gradient, typically  $<200V/\mu s$
- Limits transient over voltages at the motor terminals, typically  $<1000V$
- Suppression of mains conducted interference in lower frequency ranges
- Compensation of capacitive load currents
- Reduction of rfi emissions from the motor cable
- Reduction of motor losses and audiblenoise caused by ripple

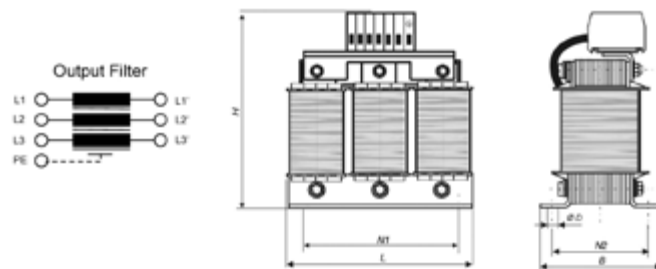
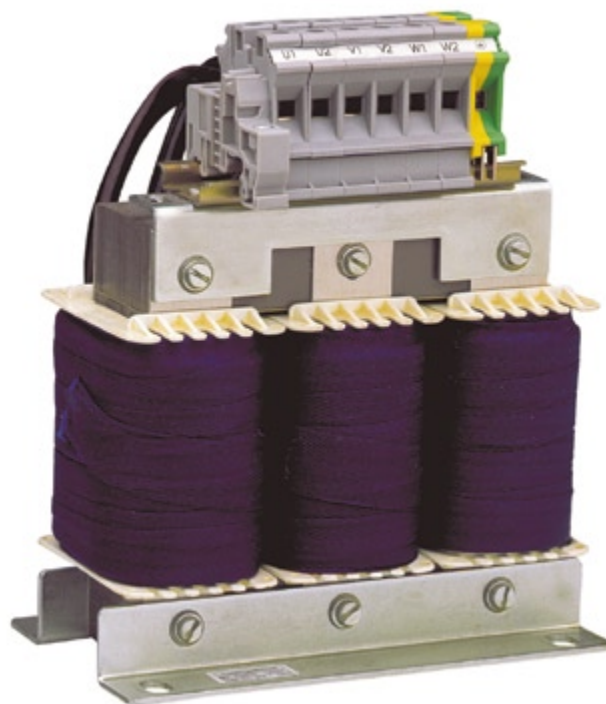

**Comparison of characteristics:**

Without filter

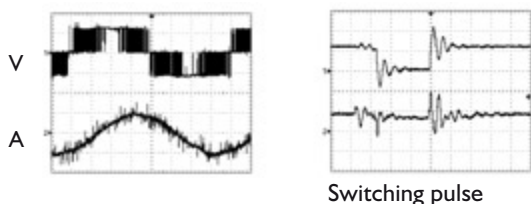

With filter

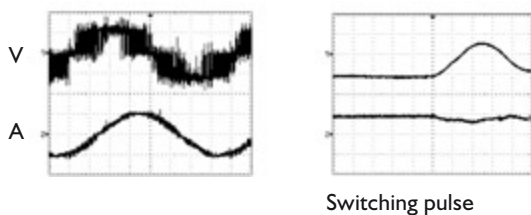

Note with filter that switching pulse rises slower and to a lower amplitude

**Specification — IP20**

Part Number	Optidrive Size	Rated Voltage	H (mm)	L (mm)	W (mm)	Mass (kg)
OD-OUTF1-IN	1	<500	112	95	70	1.5
OD-OUTF2-IN	2	<500	158	125	76	2.8
OD-OUTF3-IN	3	<500	185	155	76	4.2
OD-OUTF4-IN	4	<500	223	190	92	8.6
OD-OUTF5-IN	5	<500	260	310	180	30
OD-OUTF6-IN	6	<500	310	380	180	48

**Specification — IP55**

Part Number	Optidrive Size	Rated Voltage	H (mm)	L (mm)	W (mm)	Mass (kg)
OPT-OUTF1-IN-I55	1	<600	151	151	85	1.7
OPT-OUTF2-IN-I55	2	<600	170	151	87	3.2
OPT-OUTF3-IN-I55*	3	<600	170	151	85	3.2

\* Maximum 5.5kW  
**Note:** Dimensions include terminal box and glands where fitted

## 3ROUT

3ROUT provides 2 additional programmable relay outputs

### Specification

- Max relay switching voltage: 250V AC / 220V DC
- Max relay switching current: 1A
- Max input voltage:  $\pm 50V$  DC
- Conformity: IP00, UL94V-0
- Environmental:  $-10^{\circ}C \dots 50^{\circ}C$
- Dimensions: 56 × 33 (not pins) × 14mm

#### Product code:

**ODP-3ROUT**

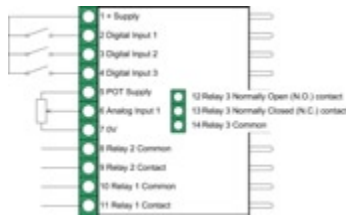

## 2ROUT

2ROUT provides a programmable second relay output

### Specification

- Max relay switching voltage: 250V AC / 220V DC
- Max relay switching current: 1A
- Max input voltage:  $\pm 50V$  DC
- Conformity: IP00, UL94V-0
- Environmental:  $-10^{\circ}C \dots 50^{\circ}C$
- Dimensions: 56 × 33 (not pins) × 14mm

#### Product code:

**ODP-2ROUT**

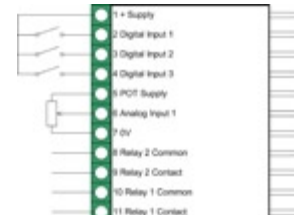

## HVACO

HVACO provides 2 relays for typical “drive running” & “drive tripped” indicators

### Specification

- Max relay switching voltage: 250V AC / 220V DC
- Max relay switching current: 1A
- Max input voltage:  $\pm 50V$  DC
- Conformity: IP00, UL94V-0
- Environmental:  $-10^{\circ}C \dots 50^{\circ}C$
- Dimensions: 56 × 33 (not pins) × 14mm

#### Product code:

**OPT-HVACO**

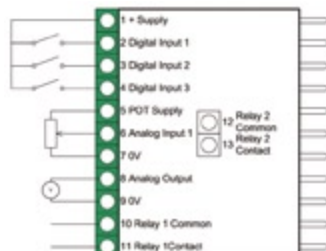

## LOGIP

LOGIP allows the digital inputs of a drive to be controlled directly from a 110V or 230V control supply without the need for interfacing relays

### Specification

- Input voltage (AC): OPT-LOGIC-11: 100 – 120 $\pm$ 10%  
OPT-LOGIC-23: 200 – 240 $\pm$ 10%
- Conformity: IP00, UL94V-0
- Environmental:  $-10^{\circ}C \dots 50^{\circ}C$
- Dimensions: 56 × 33 (not pins) × 14mm

#### Product code:

**OPT-LOGIP-11: 110V version**

**OPT-LOGIP-23: 230V version**

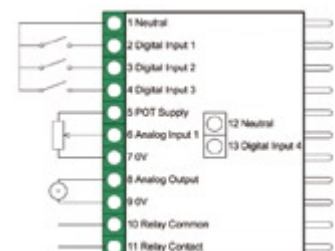

## EXTERNAL ENCODER MODULE

The external encoder feedback module has been designed to provide closed loop speed control for the Optidrive Plus drive range

The module can now introduce the Optidrive Plus into applications which require more accurate speed control or those which require encoder feedback to satisfy particular safety standards

### Key Features

- Simple plug-in interface to the Optidrive Plus using the RJ11 Interface
- Provides closed loop speed feedback control
- Encoder PPR set up through the drive keypad
- Compatible with most types of bi-directional industrial incremental encoders
- Encoder input frequencies up to 500kHz
- Bi-directional differential inputs
- LED Indicators show power on and encoder status
- Encoder status can be shown on drive display

### Typical Configuration

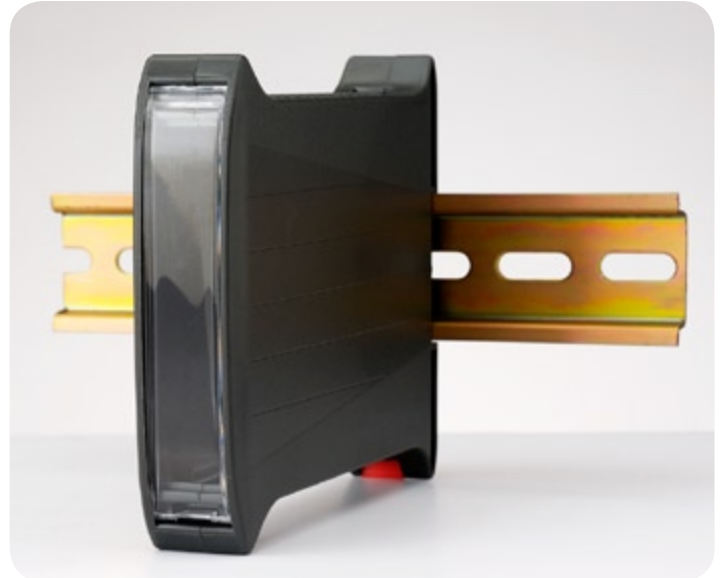

### Industry Sectors

- Food Processing
- Bottling
- Pumping
- Chemical
- Waste Water
- HVAC
- Conveyors

### Specification

- Size (L × W × H): 120 × 23 × 102 mm (4.72 × 0.9 × 4")
- Power Supply: +24V via drive RJ11
- Encoder Supply 5V DC up to 200mA available
- Encoders up to 24V require an external power supply
- Operating Temperature: 0 to 50°C
- Non-Operating Temperature: 0 to 60°C
- Mounting: DIN Rail
- Protection Class: IP00
- Conformity: CE marked

**Product code:**  
**ODP-ENCOD**

## OPTIPOINT PLUS / E2

### Remote Keypad and Display

Optiport units act as the remote keypad and display for the Optidrive on the network which has the same serial address. The physical layout and the operation of the Optiport keypad and display mimic the Optidrive exactly

Optiport Plus connects to either a single Optidrive Plus 3<sup>GV</sup> / VTC or a network of Optidrives using an electrical interface. Optiport E2 connects to Optidrive E2 units, either singularly or in a network



#### Key Benefits

- Real-time keypad and display operation mimics Optidrive
- Single electrical interface for power and data
- Communicates with any compatible drive across a network
- Automatic connection to compatible drives
- IP54 rated when through panel mounted
- Bright LED Display
- Membrane keypad
- Parameter lock function available
- 3m Data Cable included

#### General Specification

- Signal Interface: 6-way RJ11 or 8-way RJ45
- Supply Input: 10—36V DC, 30mA
- RS485 signal: Industry standard 2 wire +5V differential
- Operating Temperature: 0°C to 50°C
- Storage Temperature: -40°C to 60°C
- Relative Humidity: <95% (non condensing)
- Protection Rating: IP54

#### Product code:

**OD-OPRTP-IN (Optidrive Plus 3<sup>GV</sup> and VTC)**  
**OPT-OPORT (Optidrive E2)**

#### Optiport Plus and E2 Configurations

- One Optiport Plus with one drive



- One Optiport Plus with multiple drives

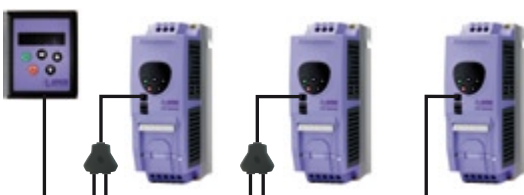

#### Optiport Plus Only Configurations

- Two Optiport Plus units with one drive

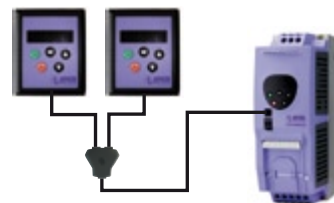

- Two Optiport Plus units with multiple drives



## 485SP RS485 Data Cable Splitter

RS485 data cable splitter is an RJ11 or RJ45 1 to 2-way connection block

**Product code:**

**OD-485SP (RJ11 1-2 way)**  
**OPT-RJ45SP (RJ45 1-2 way)**



## DATA CABLES

### OPTIDRIVE PLUS & VTC

**Product code: OD-48503**  
RJ11 to RJ11 RS485 Data Cable, 0.3m length, Black

**Product code: OD-48510**  
RJ11 to RJ11 RS485 Data Cable, 1.0m length, Black

**Product code: OD-48530**  
RJ11 to RJ11 RS485 Data Cable, 3.0m length, Black

### OPTIDRIVE E2

**Product code: OPT-J4505**  
RJ45 to RJ45 RS485 Data Cable, 0.5m length, Blue

**Product code: OPT-J4510**  
RJ45 to RJ45 RS485 Data Cable, 1.0m length, Blue

**Product code: OPT-J4530**  
RJ45 to RJ45 RS485 Data Cable, 3.0m length, Blue



## 485AD PC Connection Kit

485AD PC Connection Kit is an isolated USB to RS485 communications adaptor designed for use with Optistore V3

**Product code:**

**OD-485AD**



### Key Benefits

- To provide interface between PC and drive
- For use the Optistore V3 PC software
- Panel mount possibility
- Provides electrical isolation between PC and drive network

### Components in the package

- USB-485 adaptor
- User and Installation guides
- Optistore V3 Installation CD
- USB cable
- DB9 – RJ11 cable
- DB9 – RJ45 cable
- Windows driver CD

### Configuration

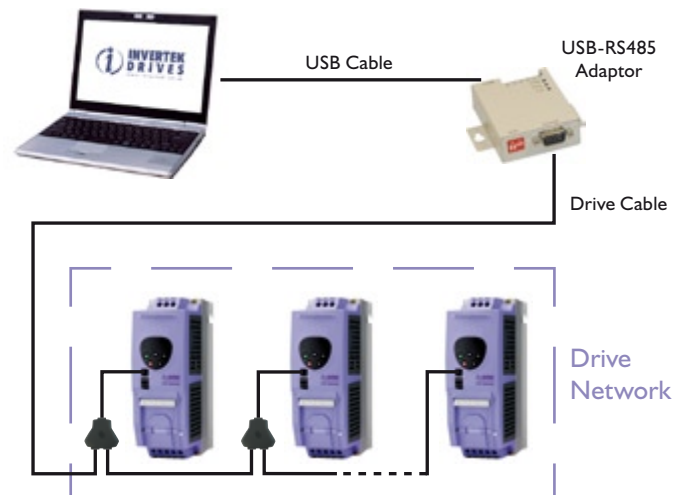

# OPTIWAND PDA OPTIWAND SP

## Unique Wireless Programming Tool

Optiwand software is a Windows Compact Edition application, available as Optiwand PDA for Pocket PC's (PDAs) and Optiwand SP for Smartphones. This unique concept allows users to commission drives and retain parameter records without the requirement for an expensive laptop PC or complex connection cables, saving both time and costs. Parameter sets are stored as files for simple editing and later transfer to a PC. Communication can take place through transparent materials, such as glass and perspex

### Key Operating Features

- Real Time Parameter Access and Monitoring
- Infra Red based comms, no cable required
- Multi Language
- Online Parameter Help and Descriptions
- Fast Copy Facility
- Remote Control and Monitoring

Optiwand SP and Optiwand PDA are compatible with most Pocket PCs and Smartphones running the Windows Mobile 5.0 or later operating systems with infrared capability.

### Website Download

Optiwand software is available as a free download from our website: [www.invertek.co.uk](http://www.invertek.co.uk)

### Drive Compatibility

- Optiwand SP – Optidrive E2
- Optiwand PDA – Optidrive E2, Plus, VTC



- Screen parameter editing screen:

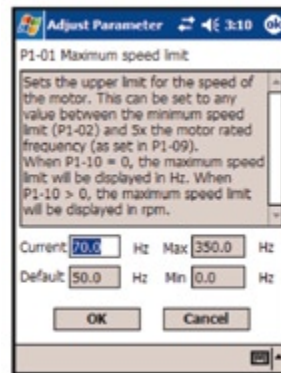

- Screen showing internal parameter monitoring:

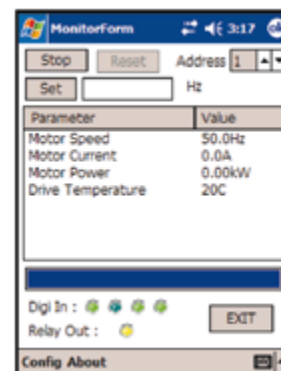

# OPTISTORE V3

## PC Programming Tool

Optistore V3 is a NEW Windows application, allowing quick and accurate communication with Optidrives for parameter management, network monitoring & firmware upgrades

### Key Benefits

Optistore V3 now replaces the existing Optistore Plus with the following new features:

- Firmware upgrades of Optidrive Plus & VTC now possible
- Plug and go, simple and easy PC control
- Individual drive or drive network management including monitoring and control
- PC based data storage and file management
- Parameter set transfer to or from Optidrives
- Fully compatible with Optiwand PDA, pocket PC software
- File management: naming, storing, printing, emailing etc.
- Parameter Export facility allows the user to insert parameter settings in other programs (e.g. Microsoft Word; \*.rtf or \*.txt formats)

### Optidrive Compatibility

The software is compatible with the following Optidrive Products:

- Optidrive Plus 3<sup>GV</sup> (including Vertical Market Solutions and all IP & NEMA ratings)
- Optidrive VTC
- Optidrive E2 (Standard, 1 phase output and all IP & NEMA ratings)
- Optidrive Compact

### System Requirements

<b>Supported Operating Systems</b>	Windows Vista; Windows XP
<b>Processor</b>	400MHz Pentium processor or equivalent (Minimum); 1 GHz Pentium processor or equivalent (Recommended)
<b>RAM</b>	96 MB (Minimum); 256 MB (Recommended)
<b>Hard Disk</b>	Up to 2MB of available space may be required
<b>Display</b>	800 × 600, 256 colours (Minimum); 1024 × 768 high colour, 32-bit (Recommended)
<b>Additional Software</b>	Microsoft .NET Framework 3.5 or later is required. If required, OptiStore will initiate a download from the Microsoft website and install .NET framework automatically.
<b>Additional Hardware</b>	Communication with the Optidrive requires an RS485 data connection. Most computers DO NOT have this connection. Invertek Drives recommends the use of the USB to RS485 Adaptor (Invertek Part: OD-485AD)

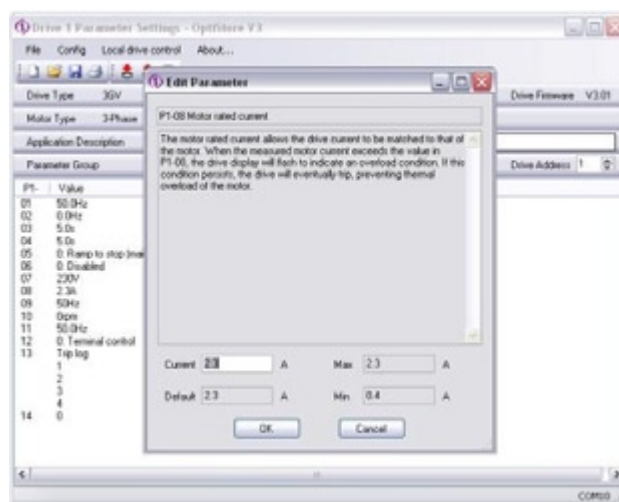
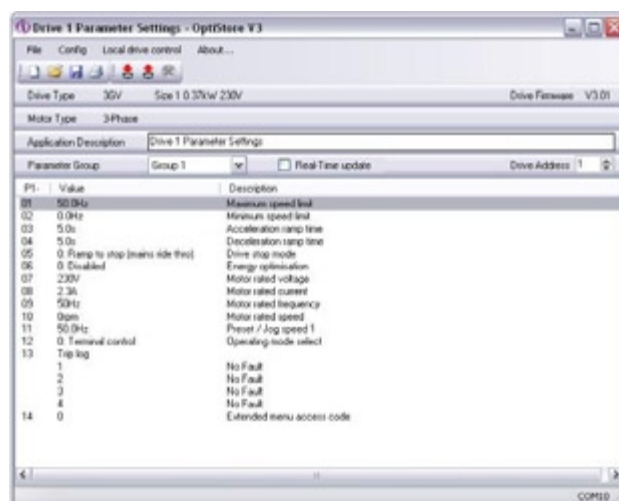
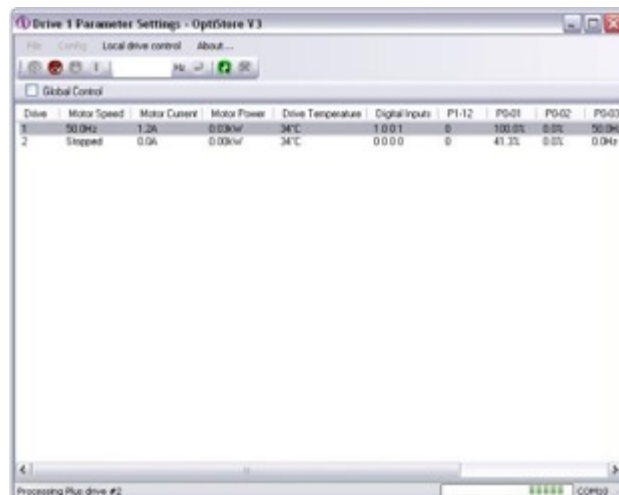

# FIELDBUS COMMUNICATION

Optidrive to Fieldbus & Industrial Ethernet Gateway family incorporating the Anybus Communicator. Ideal for factory, building and process automation industries

Anybus Communicator can connect an Optidrive with a MODBUS RTU RS485 communication interface to Fieldbus and Industrial Ethernet networks. The Communicator performs an intelligent conversion between the serial protocol and the chosen industrial network. The translation between the serial protocol and the network is configured by Invertek.



## Technical Specification

**Size (L×W×H):** 120 × 75 × 27mm (4.72 × 2.95 × 1.06")

**Power Supply:** 24V ± 10% Consumption:  
Max 280 mA on 24V Typically 100 mA

**Temperature:** Operating 0°C to 55°C  
Non-Operating -5°C to 85°C

**Mounting:** DIN-rail, PE via DIN-rail

**Protection Class:** IP20

**EMC Certification:** CE marked, UL & cUL conformance

**Conformance:** Tested and verified for fieldbus conformance

Available for:

-  **DeviceNet**
-  **Profibus-DP**
-  **Ethernet**



Product Code	Network Type	Comprises	Default Number of drives	Maximum Number of drives
OD-PROFB-IN	Profibus DP	Profibus gateway with RJ11 - 9 way D type & RJ45 - 9 way D type data Cables	4	8
OD-DEVNET-IN	DeviceNet	DeviceNet gateway with RJ11 - 9 way D type & RJ45 - 9 way D type data Cables	4	4
OD-ETHNET-IN	Ethernet	Ethernet gateway with RJ11 - 9 way D type & RJ45 - 9 way D type data Cables	4	4

Each gateway module is pre-programmed by Invertek for the default number of drives. The gateway can be configured to match the number of drives connected (up to the max). The configuration files are available upon request from Invertek.

There are 2 cables supplied with the Gateway, one is for connecting to an Optidrive Plus & VTC drive network (RJ11), the second is for connecting to an Optidrive E2 network (RJ45). It is not possible to mix Optidrive Plus and Optidrive VTC drives with Optidrive E2 drives from a single gateway module.



# OPTIONS COMPATIBILITY

Product Code	Description	ODE	ODE-2	ODP	VTC
OD-F1121	OPTIFILTER, SIZE 1, 220–240V, 1 PHASE, RFI	●	●	●	●
OD-F2121	OPTIFILTER, SIZE 2, 220–240V, 1 PHASE, RFI	●	●	●	●
OD-F1341	OPTIFILTER, SIZE 1, 220–480V, 3 PHASE, RFI	●	●	●	●
OD-F2341	OPTIFILTER, SIZE 2, 220–480V, 3 PHASE, RFI	●	●	●	●
OD-F3341	OPTIFILTER, SIZE 3, 220–480V, 3 PHASE, RFI		●	●	●
OD-BRI00	BRAKE RESISTOR, SIZE 2, 100R, 200W		●	●	●
OD-BRES4	BRAKE RESISTOR, SIZE 4, 33R, 500W			●	●
OPT-BR050-IN-155	IP55 BRAKE RESISTOR, SIZE 2, 50R, 200W		●	●	●
OD-ILI21	INPUT INDUCTOR, SIZE 1, 220–240V, 1 PHASE, IP00	●	●	●	●
OD-IL221	INPUT INDUCTOR, SIZE 2, 220–240V, 1 PHASE, IP00	●	●	●	●
OD-ILI43	INPUT INDUCTOR, SIZE 1, 380–480V, 3 PHASE, IP00	●	●	●	●
OD-IL243	INPUT INDUCTOR, SIZE 2, 380–480V, 3 PHASE, IP00	●	●	●	●
OD-IL343	INPUT INDUCTOR, SIZE 3, 380–480V, 3 PHASE, IP00		●	●	●
OD-ILI21-IN-155	INPUT INDUCTOR, SIZE 1, 220–240V, 1 PHASE, IP55	●	●	●	●
OD-IL221-IN-155	INPUT INDUCTOR, SIZE 2, 220–240V, 1 PHASE, IP55	●	●	●	●
OD-ILI63-IN-155	INPUT INDUCTOR, SIZE 1, <600V, 3 PHASE, IP55	●	●	●	●
OD-IL263-IN-155	INPUT INDUCTOR, SIZE 2, <600V, 3 PHASE, IP55	●	●	●	●
OD-IL363-IN-155	INPUT INDUCTOR, SIZE 3, <600V, 3 PHASE, IP55		●	●	●
OD-OUTF1	OUTPUT FILTER, SIZE 1, 480V, IP00	●	●	●	●
OD-OUTF2	OUTPUT FILTER, SIZE 2, 480V, IP00	●	●	●	●
OD-OUTF3	OUTPUT FILTER, SIZE 3, 480V, IP00		●	●	●
OD-OUTF4	OUTPUT FILTER, SIZE 4, 480V, IP00			●	●
OD-OUTF5	OUTPUT FILTER, SIZE 5, 480V, IP00			●	●
OD-OUTF6	OUTPUT FILTER, SIZE 6, 480V, IP00			●	●
OD-OUTF1-155	OUTPUT FILTER, SIZE 1, 480–600V, IP55	●	●	●	●
OD-OUTF2-155	OUTPUT FILTER, SIZE 2, 480–600V, IP55	●	●	●	●
OD-OUTF3-155	OUTPUT FILTER, SIZE 3, 480–600V, IP55		●	●	●
ODP-PICON	PI CONTROL CARD (+24V Drives)		●	●	●
ODE-PICON	PI CONTROL CARD (+10V Drives)	●			
OPT-HVACO	HVAC RELAY OUTPUT		●	●	●
ODE-2ROUT	DUAL RELAY OUTPUT (+10V Drives)	●			
ODP-2ROUT	DUAL RELAY OUTPUT (+24V Drives)		●	●	●
ODP-3ROUT	3 RELAY OUTPUT			●	●
OPT-LOGIP-11	110V INPUT CARD		●	●	●
OPT-LOGIP-23	230V INPUT CARD		●	●	●
ODP-ENCOD	EXTERNAL ENCODER MODULE (ODP Only)			●	
OPT-OPORT	OPTIPOINT E2, REMOTE KEYPAD		●		
OD-OPRTP	OPTIPOINT PLUS, REMOTE KEYPAD			●	●
OPT-J4505	RJ45 DATA CABLE, 0.5m		●		
OPT-J4510	RJ45 DATA CABLE, 1.0m		●		
OPT-J4530	RJ45 DATA CABLE, 3.0m		●		
OPT-J45SP	RJ45 DATA CABLE SPLITTER		●		
OD-48503	RJ11 DATA CABLE, 0.3m			●	●
OD-48510	RJ11 DATA CABLE, 1.0m			●	●
OD-48530	RJ11 DATA CABLE, 3.0m			●	●
OD-485SP	RJ11 DATA CABLE SPLITTER (CABLE WITH RJ11 TERMINATIONS)			●	●
OD-485AD	PC CONNECTION KIT for use with Optistore V3 Software		●	●	●
OD-OWDCE	OPTIWAND Software installed on a Pocket PC		●	●	●
OPT-STICK	OPTISTICK		●		
OD-PROFB	PROFIBUS GATEWAY		●	●	●
OD-DEVNET	DEVICENET GATEWAY		●	●	●
OD-ETHNET	ETHERNET GATEWAY		●	●	●

# TRAINING COURSES

Invertek Drives delivers training on product selection, application, service and repair at its dedicated Innovation Centre in Welshpool, UK

Training is at the forefront of Invertek Drives' Worldwide operations and is a core part of its strategy to exceed customer expectations.

The courses are delivered to sales partners, OEM customers and end-users from around the World and are under continual review to ensure delegates benefit from the most up to date information and industry knowledge.

## Topics Covered

Each course is tailored to best suit its purpose and target audience but you can always expect a comprehensive agenda.

### Product Features and Specifications

- Standard Features
- Product Differentiation and Selection Tables
- Option Expansion Cards
- Documentation
- Detailed Specifications
- Sizing and Selection
- Torque and Speed Requirements
- Inverter Selection Tables

### Installation and Wiring

- Power Wiring
- Control Wiring

### Startup Procedures

- Keypad Operation
- Software Operation

### Setting Parameters

- Display Parameters
- Setpoints and Ramps
- Speed Control

### Maintenance and Troubleshooting

- Fault Memory
- Fault Finding and Diagnosing



For more information on upcoming courses, contact Invertek Drives or login to iSource

[www.invertek.co.uk](http://www.invertek.co.uk)





**INVERTEK  
DRIVES**  
www.invertek.co.uk

Global Solutions



**South Africa**  
Heavy-duty hoisting control



**Australia**  
Polyethylene film manufacturing



**Italy**  
Water cooling systems in the Steel industry

**Washdown Duty**  
Drives designed for harsh environments



whatever your application needs  
**OPTIDRIVE** puts you in total control

[www.invertek.co.uk](http://www.invertek.co.uk)

Global drive solutions...

Over 60 sales partners  
around the World



85-IDLBR-00 Stock Drives Catalogue V3.2.2



REGIONAL DISTRIBUTOR

Invertek Drives Ltd adopts a policy of continuous improvement and whilst every effort has been made to provide accurate and up to date information, the information contained in this catalogue should be used for guidance purposes only and does not form part of any contract.

[www.invertek.co.uk](http://www.invertek.co.uk)

**INVERTEK DRIVES LIMITED  
UK HEAD OFFICE**

Offa's Dyke Business Park  
Welshpool, Powys. UK  
SY21 8JF

**Tel:** +44 (0)1938 556868  
**Fax:** +44 (0)1938 556869  
**sales@invertek.co.uk**



All rights reserved. No part of this brochure may be reproduced or transmitted in any form or by any means, electrical or mechanical including photocopying, recording or by any other form of information storage or retrieval system without permission in writing from the publisher.